

BYD Seal (UX) 12/2023 >>  
 BYD Seal U (UC) 02/2024 >>  
 BYD Seal U DM-i (PHEV) (UC) 06/2024 >>  
 BYD Seal Lion 7 (SB) 10/2024 >>

Partnr.: BD-007-DX

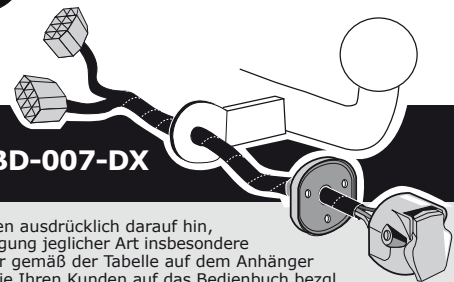

- DE** • Einbauanleitung Elektrosatz Anhängervorrichtung mit 13-P Steckdose lt. DIN/ISO Norm 11446. • Wir weisen ausdrücklich darauf hin, dass eine unsachgemäße und nicht in einer Fachwerkstatt durchgeführte Montage einen Verzicht auf Entschädigung jeglicher Art insbesondere bezüglich des Produkthaftpflichtrechts zur Folge hat. • Technische Änderungen vorbehalten. • Widerstand nur gemäß der Tabelle auf dem Anhänger verwenden. • Achtung! Bitte lesen Sie vorab diese Anleitung, nehmen Sie diese zur Kenntnis und verweisen Sie Ihren Kunden auf das Bedienbuch bezgl. der eventuell zu treffenden Maßnahmen zum Ziehen eines Anhängers. • Bei Funktionsproblemen ist die Fehlersuche auf ca. 0,5 Stunden zu begrenzen, kontaktieren Sie die ECS Technical Support: ts@ecs-electronics.nl / 00800 22552327
- FR** • Instructions de montage du faisceau électrique pour crochet d'attelage conforme à la norme DIN/ISO 11446 prise 13-P. • Il est expressément prévu qu' on ne saurait se prévaloir d'un quelconque préjudice contractuel ou réhibitoire si le montage avait été fait en dépit des dites instructions ou dans un garage ne disposant pas des équipements adéquats. • Sous réserve de modifications techniques. • Ne excédez pas la charge maximale, indiquée dans le tableau. • Attention! Avant de commencer le branchement, on vous prie de prendre compte des connections à faire dans la notice, ainsi que communiquer directement à votre client les mesures à prendre pour tirer une remorque. • S'il y a des problèmes de fonctionnement, limiter la recherche de défauts à env. 30 minutes et contacter ECS l'Aide en ligne: ts@ecs-electronics.nl / 00800 22 55 23 27.
- NL** • Montage-handleiding elektrokabelset voor trekhaak met 13-P contactdoos vlg. DIN/ISO norm 11446. • Wij wijzen er met nadruk op, dat ondeskundige en niet door een vakkundige werkplaats uitgevoerde montage tot gevolg heeft dat daardoor ieder recht op schadevergoeding, ook op wettelijke aansprakelijkheid inzake producten, vervalt. • Technische wijzigingen voorbehouden. • Gebruik alleen belasting volgens aansluittabel op het getrokken voertuig. • Opgelet! Wij verzoeken U dringend vooraf deze instructie door te nemen, hiervan kennis te nemen en uw cliënt te verwijzen naar het instructieboekje betreffende de eventueel te nemen maatregelen voor het trekken van een aanhangwagen. • Bij werkingsproblemen moet de foutencontrole tot ca. 0,5 uur beperkt worden, neem contact op met de ECS Technical Support: ts@ecs-electronics.nl / 00800 22 55 23 27.
- GB** • Fitting instructions electric wiring kit tow bar with 13-P socket up to DIN/ISO Norm 11446. • We would expressly point out that assembly not carried out properly by a competent installer will result in cancellation of any right to damage compensation, in particular those arising by virtue of the product liability act. • Contents of these kits and their fitting manuals are subject to alteration without notice, please ensure that these instructions are read and fully understood before commencing installation. • Do not overload circuits; the maximum loads per connection are detailed in this manual. • Attention! Before Installation, please read this manual carefully and inform your customer to consult the vehicle owners manual to check for any vehicle modifications required before towing. • In the event of functional problems, troubleshooting must be limited to about 0.5 hours, contact the ECS Technical Support: ts@ecs-electronics.nl / 00800 22 55 23 27.
- ES** • Instrucciones de montaje de kit eléctrico para enganche de remolque con caja de conexiones 13-P según norma DIN/ISO 11446. • El montaje inapropiado y efectuado por personal no cualificado originará la pérdida de todo derecho a indemnización o la expiración de toda responsabilidad civil con respecto al producto. • Nos reservamos el derecho a efectuar modificaciones técnicas. • Utilice sólo cargas de acuerdo a la tabla de conexión del vehículo remolcado. • Atención: lea atentamente este manual antes de la instalación e informe al cliente que debe consultar el manual de usuario del vehículo para conocer cualquier modificación realizada. • En caso de tener problemas con su funcionamiento, la búsqueda de errores está limitada a aprox. 0,5 horas, por lo que le recomendamos ponerse en contacto con el servicio de atención telefónica: ts@ecs-electronics.nl / 00800 22 55 23 27.
- IT** • Istruzioni di montaggio di set di cavi elettrici per gancio da traino con zoccolo a 13-P conforme alla norma DIN/ISO 11446. • Sottolineiamo espressamente che un montaggio inadeguato ed eseguito da un'officina non specializzata ha come conseguenza il decadere di qualsiasi diritto al risarcimento danni, nonché alla responsabilità legale relativa ai prodotti. • Ci si riserva il diritto di apportare modifiche tecniche. • Utilizzare esclusivamente un carico conforme alla tabella degli allacci relativa al veicolo in questione. • Attenzione! Vi invitiamo a leggere attentamente questo manuale e a invitare a vostra volta i clienti a leggere il manuale del conducente sulle eventuali misure da prendere per l'attacco di un rimorchio. • In caso di problemi di funzionamento, la ricerca di errori dovrebbe essere limitata a circa 0,5 ore. Contattare il centralino di assistenza per i fasci di cavi: ts@ecs-electronics.nl / 00800 22 55 23 27.
- SE** • Monteringsanvisningar elkabelsats för dragkrok med 13-P kontaktdosa enligt DIN/ISO norm 11446. • Vi påpekar med eftertryck att all rätt till skadeersättning och all laglig ansvarighet förfaller om monteringen inte har utförts på rätt sätt och av en professionell verkstad. • Tekniska ändringar förbehålles. • Använd endast belastning enligt anslutningstabellen på det dragna fordonet. • Varning! Innan installation, läs den här handboken noga och informera din kund om att läsa fordonets användarhandbok för att undersöka vilka eventuella ändringar som behöver göras på fordonet. • Vid funtionsproblem ska felsökningen begränsas till ca 0,5 timme, kontakta reservdels-helpline ts@ecs-electronics.nl / 00800 22 55 23 27.
- CZ** • Montážní pokyny: souprava pro elektrické propojení tažné tyče s 13-P zásuvkou do normy DIN/ISO 11446. • Výslovně zdůrazňujeme, že jakákoli montáž, která není provedená ve specializované dílně, má za následek odvolání nároků na kompenzaci jakéhokoli druhu, obzvláště vyplývajících ze zákona o odpovědnosti za způsobené škody. • Změny mohou být provedeny bez oznámení. • Používejte pouze při maximálním nabití podle tabulky na taženém vozidle. • Upozornění! Prosíme, abyste si nejdříve přečetli tyto instrukce, seznámili se s nimi a odkázali své zákazníky na příručku týkající se případných opatření, která musí být přijata pro tažení přívěsu. • Při problémech funkčnosti je třeba vyhledávání chyb omezit na cca 0,5 hodiny, kontaktujte ECS Technical Support: ts@ecs-electronics.nl / 00800 22 55 23 27.
- DK** • Monteringsvejledninger for det elektriske ledningsføringssæt for trækstang med 13-P stikdåse, DIN/ISO, norm 11446. • Vi ønsker at gøre udtrykkeligt opmærksom på atfærdet samling, der ikke er udført af et specialiseret værksted, resulterer i bortfaldelse af kompensationskrav af alle slags, i særdeles krav der måtte opstå omkring det lovligtige ansvar. • Kan ændres uden varsel. • Brug kun den maksimale belastning, i overensstemmelse med forbindelsestabelen for bugserede køretøjer. • OBS! For installation skal denne vejledning læses omhyggeligt og din kunde skal informeres om at kigge i køretøjets håndbog for at kontrollere om der skal laves eventuelle ændringer på køretøjet inden bugsering. • Ved funktionsproblemer skal fejlsøgningen begrænses til ca. 0,5 time, kontakt ECS Technical Support: ts@ecs-electronics.nl / 00800 22 55 23 27.
- FI** • Ohjeet vetokoukun sähkökaapelisarjan asentamiseen, jossa on DIN/ISO 11446 mukainen 13-P liitin. • Korostamme, että kaikki oikeudet vahinkokorvaukseen kuten myös valmistajan laillinen vastuu raukeavat, mikäli asennusta ei ole toteutettu oikealla tavalla eikä ammattitaitoisen asiantuntijan toimesta. • Oikeus teknisiin muutoksiin ilman erillistä huomautusta pidätetään. • Huomio! Lue tämä käyttöoppas huolellisesti ennen asennusta ja tiedota asiakkaita tarkistamaan kaikki ajoneuvon muutoksen ajoneuvon omistajan käyttöoppaas ennen hinausta. • Kuormita työvirtapiiriä ainoastaan hinattavan ajoneuvon kytkentäkaavin mukaisesti. • Virhehaku on rajoitettava toiminto-ongelmien esiintyessä noin 0,5 tuntiin, ota yhteys ECS Technical Support: ts@ecs-electronics.nl / 00800 22 55 23 27.
- GR** • Οδηγίες συναρμολόγησης ηλεκτρικού σετ καλωδίων μπάρας ρυμούλκησης με υποδοχή 13-P μέχρι DIN/ISO Κανόνας 11446. • Επισημαίνουμε κατηγορηματικά ότι οποιαδήποτε εφαρμολογία συναρμολόγησης, η οποία δεν έχει πραγματοποιηθεί ειδικό εργαστήριο θα οδηγήσει σε αποποίηση των αξιώσεων επιβολής αποζημιώσεων οποιασδήποτε είδους, ειδικά όσα προκύπτουν από το νόμο ευθύνης προϊόντων. • Μπορεί να τροποποιηθεί χωρίς προηγούμενη ειδοποίηση. • Χρησιμοποιείτε μόνο μέγιστο ηλεκτρικό φορτίο σύμφωνα με τον πίνακα σύνδεσης στο ρυμούλκούμενο όχημα. • Προσοχή! Πριν την εγκατάσταση, διαβάστε το χειρίδιο αυτό προσεκτικά και ενημερώστε τον πελάτη σας να συμβουλευτεί το χειρίδιο ιδιοκτητήτων οχήματος ώστε να ελέγξει τυχόν τροποποιήσεις που απαιτούνται στο όχημα πριν τη ρυμούλκηση. • Σε περίπτωση προβλημάτων λειτουργίας να περιοριστεί η αναζήτηση σφαλμάτων σε περί. 0,5 δευτ., επικοινωνήστε με τη γραμμή υποστήριξης ECS Technical Support: ts@ecs-electronics.nl / 00800 22 55 23 27.
- NO** • Monteringsanviser elkabelsett for trekkrok med 13-P koblingsboks ifølge DIN/ISO norm 11446. • Vi påpeker ettertrykkelig at all rett til skadeerstatning og rettslig ansvar forfaller dersom monteringen ikke er blitt utført på riktig måte og av et profesjonelt verksted. • Tekniske endringer forbeholdes. • Overskrid ikke grensene anviset i tilkoblingstabellen på tilhengeren eller det tilkoblede kjøretøyet. • OBS! Les denne bruksanvisningen nøye før installasjon. Be kunden om å rådføre seg med brukerhåndboken for kjøretøyeiere for å sjekke om kjøretøyet må modifiseres før tauing. • Ved funksjonsproblemer må feilsøket begrenses til ca. 0,5 timer, kontakt ECS Technical Support: ts@ecs-electronics.nl / 00800 22 55 23 27.
- PL** • Instrukcje montażu zestawu okablowania elektrycznego dysza holowniczego z 13-P stykowym gniazdem DIN/ISO 11446. • Chcielibyśmy wyraźnie zaznaczyć, iż wszelki nieprawidłowy montaż, który nie jest wykonywany w specjalistycznym warsztacie pociąga za sobą utratę możliwości dochodzenia wszelkiego typu roszczeń, w szczególności tych wynikających z odpowiedzialności producenta za swój produkt. • Podlega zmianom bez powiadomienia. • Używać tylko takiego maksymalnego obciążenia które wynika z tabliczki połączeń holowanego pojazdu. • Uwaga! Przed zainstalowaniem należy dokładnie przeczytać tę instrukcję i poinformować klienta o konieczności sprawdzenia w instrukcji posiadacza pojazdu w celu sprawdzenia przed holowaniem, czy nie wprowadzono do pojazdu jakichkolwiek zmian. • W przypadku problemów ograniczyć wyszukiwanie błędów do ok. 0,5 godziny, skontaktować się z linią serwisową ts@ecs-electronics.nl / 00800 22 55 23 27.

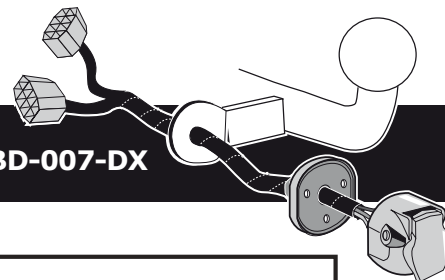
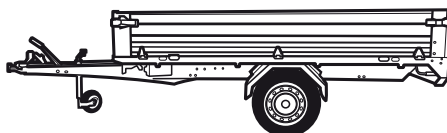
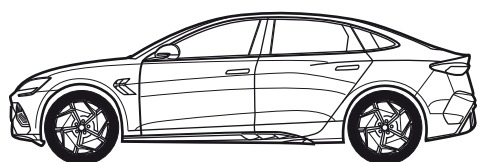

## Information

Partnr.: BD-007-DX

### INFO

#### Bitte beachten:

Dieser Elektro-Einbausatz hat keinen Einfluss auf die fahrzeugseitigen Assistenzsysteme. Im Anhängerbetrieb werden Assistenzsysteme mit Notbremsfunktion (AEB) weder beeinflusst noch automatisch deaktiviert.

(DE)

Automatische oder ferngesteuerte Einpark-Assistenzsysteme dürfen im Anhängerbetrieb nicht verwendet werden!  
Für weitere Informationen siehe Bedienungsanleitung Fahrzeug.

#### Please note:

This tow bar wiring kit has no influence on the towing vehicle's assistance systems. Assistance systems with emergency brake function (AEB) will not be influenced or automatically deactivated whilst a trailer is attached.

(GB)

Automatic or remote-controlled parking assistance systems must not be used whilst a trailer is attached!  
For more information please refer to the vehicle owner's manual.

#### Remarques:

Ce faisceau d'attelage n'a aucune influence sur les systèmes d'assistance du véhicule tracteur.

(FR)

Les systèmes d'assistance avec fonction de freinage d'urgence autonome (AEB) ne seront ni influencés, ni désactivés automatiquement lorsqu'une remorque est attelée.

Les systèmes d'assistance au stationnement automatiques ou télécommandés ne doivent pas être utilisés lorsqu'une remorque est attelée !  
Pour plus d'informations, reportez-vous au manuel d'instruction du véhicule.

#### Nota:

Este kit de cableado no influye al sistema de asistencia a la seguridad. El sistema inteligente de frenado de emergencia autónoma (AEB) no se verá afectado ni se desactivará automáticamente mientras lleve un remolque acoplado.

(ES)

No se deben de utilizar el asistente de ayuda al estacionamiento automáticos y de salida de aparcamiento o controlados a distancia.  
Para más información consulte el manual del vehículo.

#### Da notare:

Questo kit di cablaggio del gancio da traino non ha alcuna influenza sui sistemi di assistenza del veicolo trainante.

(IT)

I sistemi di assistenza con funzione freno di emergenza (AEB) non saranno influenzati o disattivati automaticamente mentre è montato un rimorchio.

I sistemi di assistenza al parcheggio automatici o telecomandati non devono essere utilizzati mentre è montato un rimorchio!  
Per ulteriori informazioni, consultare il manuale dell'utente del veicolo.

#### Let op:

Dit trekhaak kabelset heeft geen invloed op de hulpsystemen van het trekkende voertuig.

(NL)

Hulpsystemen met AEB functie (autonoom noodrem) worden niet automatisch beïnvloed of gedeactiveerd wanneer een aanhangwagen wordt aangekoppeld.

Automatische of op afstand bediende parkeerhulpsystemen mogen niet worden gebruikt wanneer een aanhangwagen wordt gekoppeld!  
Voor meer informatieve raadpleeg de instructie boekje van het voertuig.

Einzelteilliste

Liste de pieces

Onderdelenlijst

Part list

Lista de componentes

Elenco componenti

Dellista

Seznam dílů

Del-liste

Osaluettelo

Κατάλογος εξαρτημάτων

Delliste

Lista części

(DE)

(FR)

(NL)

(GB)

(ES)

(IT)

(SE)

(CZ)

(DK)

(FI)

(GR)

(NO)

(PL)

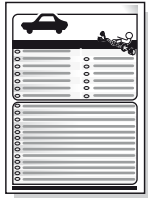
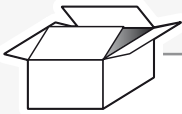

U1

U2

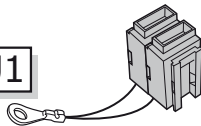

U

E1

D

C

M

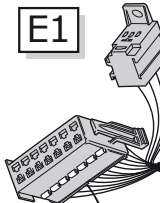

E

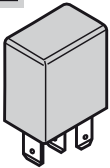

B

A



G



\* OPTION +15



5x



X

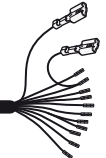

T



X

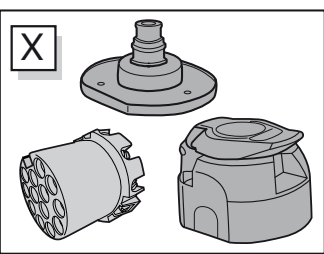

M

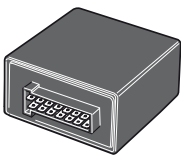

\* OPTION +15

SP478ZZ  
vorbereitung für  
préparation pour  
voorbereiding voor  
preparacion para  
preparazione per

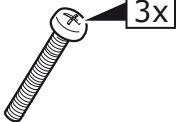
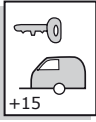

3x



3x



3x



1x



1x



2x



1x

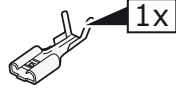

1x



2x

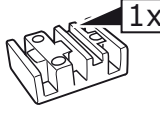

1x



B

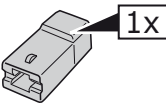

1x

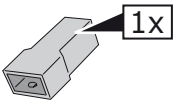

1x

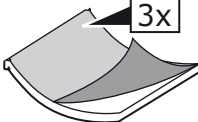

3x

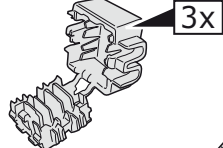

3x

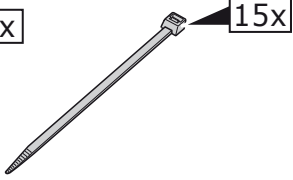

15x

SYMBOLS	ERKLÄRUNG SYMBOL	SYMBOL EXPLANATION	EXPLICATION DES SYMBOLES	SPIEGAZIONE DEI SIMBOLI	EXPLICACIÓN DE LOS SIMBOLES	VERKLARING SYMBOLEN	OBJASNIENIA SYMBOLI	VYSVETLIVKY K SYMBOLOM
	Linke Schlussleuchte (58-L)	Left taillight (58-L)	Feu arrière gauche (58-L)	Luce posteriore sinistra (58-L)	Piloto trasero izquierdo (58-L)	Linker Achterlicht (58-L)	Lewe Światło tyłne (58-L)	Ľavé zadné svetlo (58-L)
	Rechte Schlussleuchte (58-R)	Right taillight (58-R)	Feu arrière droite (58-R)	Luce posteriore destra (58-R)	Piloto trasero derecho (58-R)	Rechter Achterlicht (58-R)	Prawe Światło tyłne (58-R)	Právě zadné svetlo (58-R)
	Bremsleuchte (54) / 3. Bremsleuchte (54)	Stop light (54) / high mounted, third stop light (54)	Feu de stop (54) / 3ème feu stop (54)	Luce d'arresto (54) / 3. luce d'arresto (54)	Luz de freno (54) / tercera luz de freno (54)	Remlicht (54) / 3e remlicht (54)	Światło stop (54) / trzecie Światło stop (54)	Brzdové svetlá (54) / tretie brzdové svetlo (54)
	Fahrtrichtungsanzeiger links	Turn signal indicator left	Feu indicateur de direction gauche	Indicatore di direzione sinistra	Luz indicadora de dirección de marcha izquierda	Richtingaanzwijzer links	Kierunkowskaz lewy	Smerové svetlo ľavé
	Fahrtrichtungsanzeiger rechts	Turn signal indicator right	Feu indicateur de direction droite	Indicatore di direzione destra	Luz indicadora de dirección de marcha derecha	Richtingaanzwijzer rechts	Kierunkowskaz prawy	Smerové svetlo pravé
	Nebelschlussleuchte(n)	Rear fog light(s)	Feu (x) arrière (s) de brouillard	Fendinebbia	Luz (-ces) trasera (s) antineblia (s)	Mistachterlicht(en)	Przeciwmgielne Światło	Hmllové svetlo(á)
	Rückfahrleuchte(n)	Reversing lights(s)	Feu (x) de marche arrière	Luce (!) retromarcia	Luz (-ces) de marcha atrás	Achterruitlicht(en)	Światło wsteczne	Spatné svetlo(á)
	Dauerstrom / Steckdose 13P Kammer 9	Permanent power supply / 13pin socket, chamber 9	Courant continu / prise de courant à 13 pôles, compartiment 9	Alimentazione continua / presa 13 poli, camera 9	Positivo continuo / caja de enchufe a 13 polos, cámara 9	Continuustroom / stekkerdoos 13P kamer 9	Staly plus/gniazdo 13 biegunowe, kontakt 9	Trvalé plus/zásuvka 13 pólová, kontakt 9
	Ladelleitung / Steckdose 13P Kammer 10	Charging wire for trailer battery / 13pin socket, chamber 10	Cable de charge / prise de courant à 13 pôles, compartiment 10	Cavo di carica / presa 13 poli, camera 10	Cable de carga / caja de enchufe a 13 polos, cámara 10	Geschakelde spanning stekkerdoos 13P kamer 10	Przewód ładujący / gniazdo 13 biegunowe, kontakt 10	Nabíjací kábel/zásuvka 13. pólová, kontakt 10
	Anhänger / Anhängererkennung	Trailer / Trailer recognition	Remorque / détection de la fonction "remorque"	Rimorchio / riconoscimento rimorchio	Remolque / detección de remolque	Aanhanger / aanhanger identificatie	Przyczepa / rozpoznawanie przyczepy	Príves / rozpoznávanie prívesu
	Dauerstrom / permanente Stromversorgung	Permanent current power supply	Courant continue / alimentation électrique permanente	Corrente / alimentazione continua	Positivo continuo / alimentación de corriente permanente	Continuustroom / permanente stroomvoorziening	Staly plus / stale napięcie	Trvalé plus / stály prívod prudu
	Nach dem Kontakt	Voltage after ignition	Tension après contact	Tensione dopo il contatto	Tensión después del contacto	Geschakelde spanning	Napięcie po zeknięciu	Napätie po kontakte
	Masse (31)	Ground or Earth (31)	Masse (31)	Massa (31)	Masa (31)	Massa (31)	Masa (31)	Ukostonenie (31)
	Batteriepolklemme Anschluss Minus	Ground connection battery terminal lug	Borne "moins" de la batterie	Connessione negativa della batteria	Conexion negativa de batería	Accupoolklem aansluiting min	Klema baterii - minus	Svorka batérie - minus
	Batteriepolklemme Anschluss Plus	Positive connection battery terminal lug	Borne "plus" de la batterie	Connessione positiva della batteria	Conexion positiva de batería	Accupoolklem aansluiting plus	Klema baterii - plus	Svorka batérie - plus
	Sicherung / Sicherungsstärke 20 Ampere	Fuse / fuse capacity 20 Amp	Fusible / ampérage 20 ampères	Fusibile / fusibile con capacity 20 Ampère	Fusible / amperaje 20 amperes	Zekering / zekering sterkte 20 Ampere	Bezpiecznik / ampere 20A	Poistka / Vykon poistky 20 Amper
	Lautsprecher / Warnsummer	Loudspeaker / buzzer	Haut-parleur / vibreur	Autoparlante / cicalino	Altavoz/señal de advertencia acústica	Luidspreker / waarschuwingsoemer	Klakson	Reproduktor / klakson
	Einparkhilfe	Park distance control	Assistance au parking	Sensori di parcheggio	Ayuda para aparcar	Inparkeerhulp	Czujnik (sensor) parkowania	Parkovací senzor
	Schalter / Funktion Ursprung	Switch / source of function	Interrupteur / origine de fonction	Interruttore / origine funzione	Interruptor / origen de función	Schakelaar / functie oorsprong	Przełącznik	Prepínač / zdroj funkcie
	Verbinden	Connect together	Raccorder	Connessione	Conectar	Koppelen	Połączyć	Spojiť

SYMBOLS	ERKLÄRUNG SYMBOL (DE)	SYMBOL EXPLANATION (GB)	EXPLICATION DES SYMBOLES (FR)	SPIEGAZIONE DEI SIMBOLI (IT)	EXPLICACIÓN DE LOS SIMBOLES (ES)	VERKLARING SYMBOLEN (NL)	OBJASNIENIA SYMBOLI (PL)	VYSVETLIVKY K SYMBOLOM (SK)
	Trennen	Disconnect	Séparer	Sconnessione	Separar	Ontkoppelen	Rozłączyć	Rozpojiť
	PDC-Abschaltung	PDC cut off	Désactivation du PDC	Taglio PDC	Desactivación PDC	Deactivering PDC	Dezaktywacja PDC	Desaktivácia PDC
	Beachte ausgewählten Bereich	Look carefully at selected area	Faire attention à la zone sélectionnée	Considerare area selezionata	Considerar el área seleccionada	Let op gekozen bereik	Sledzić / wybrana część	Sledovať vybranú oblasť
	Vorhanden / belegt / i.o.	Present / Occupied / OK	Disponible / Occupé / OK	Presente / occupato / OK	Presente / ocupado / OK	Aanwezig / bezet / i.o.	Znajdujący się / w porządku	Nachádzajúci sa / osadený / v poriadku
	Nicht vorhanden / nicht belegt / nicht i.o.	Not present / Not occupied / not OK	Pas disponible / pas occupé / pas OK	Non presente / non occupato / non OK	Non presente / non OK	Afwezig / bezet / i.o	Nie znajdujący się / nie w porządku	Nenachádzajúci sa / neosadený / nie jr v poriadku
	Links	Left	Gauche	Sinistra	Izquierdo	Links	Na lewo	Naľavo
	Rechts	Right	Droite	Destra	Derecho	Rechts	Na prawo	Napravo
	Akustische Signalisierung	Acoustic indication	Signalisation acoustique	Segnalazione acustica	Señalización acustica	Akoestische signalering	Dźwiękowa sygnalizacja	Zvuková signalizácia
	Achtung / wichtiger Hinweis	Attention / important advice	Attention / indication importante	Attenzione / indicazione importante	Atención / indicación importante	Attentie / belangrijke instructie	Uwaga / ważna informacja	Pozor / dôležitá informácia
	Wiederverwendbar	Reusable	Réutilisable	Riutilizzabile	Reutilizable	Herbruikbaar	Wielokrotnego użytku	Opakované použiteľné
	Mülleimer	Trash bin	Poubelle	Bidone della spazzatura	Papelera	Prullenbak	Pojemnik na odpady	Odpadkový koš
	Klebeband verwenden	Use tape	Utiliser du ruban adhésif	Utilizzare il nastro adesivo	Utilizar cinta adhesiva	Gebruik tape	Używać taśmy	Použiť pásky
	Option	Option	Option	Opzione	Opción	Optie	Opcja	Možnosť
	Informationen	Information	Information	Informazione	información	Informatie	Informacja	Informácie
	Messen Sie die Spannung	Measure the voltage	Mesurer la tension	Misurare la tensione	Medir la tensión	Meet de spanning	Pomiar napięcia	Meranie napätia
	Normal öffnen Normalerweise schließen Gemeinsam	Normally open Normally close Common	Normalement ouvert Normalement fermé Commun	Normalmente aperto Normalmente chiuso Comune	Normalmente abierto Normalmente cerrado Común	Normaal open Normaal dicht Common	Normalnie otwarty Normalnie zamknięty Powszechny	Normálne otvorené Normálne zatvorené Spoločné

**INFO**

	BK	BN	BU	GY	GN	WH	YE	OG	PE	PI	RD
DE	Schwarz	Braun	Blau	Grau	Grün	Weiß	Gelb	Orange	Violett	Rosa	Rot
FR	Noir	Marron	Bleu	Gris	Vert	Blanc	Jaune	Orange	Violet	PI	Rouge
NL	Zwart	Bruin	Blauw	Grijs	Groen	Wit	Geel	Oranje	Paars	Roze	Rood
GB	Black	Brown	Blue	Grey	Green	White	Yellow	Orange	Purple	Pink	Red
ES	Negro	Marrón	Azul	Gris	Verde	Blanco	Amarillo	Naranja	Morado	Rosa	Rojo
IT	Nero	Marrone	Blui	Grigio	Verde	Bianco	Giallo	Arancione	Viola	Rosa	Rosso

**ROUTING**

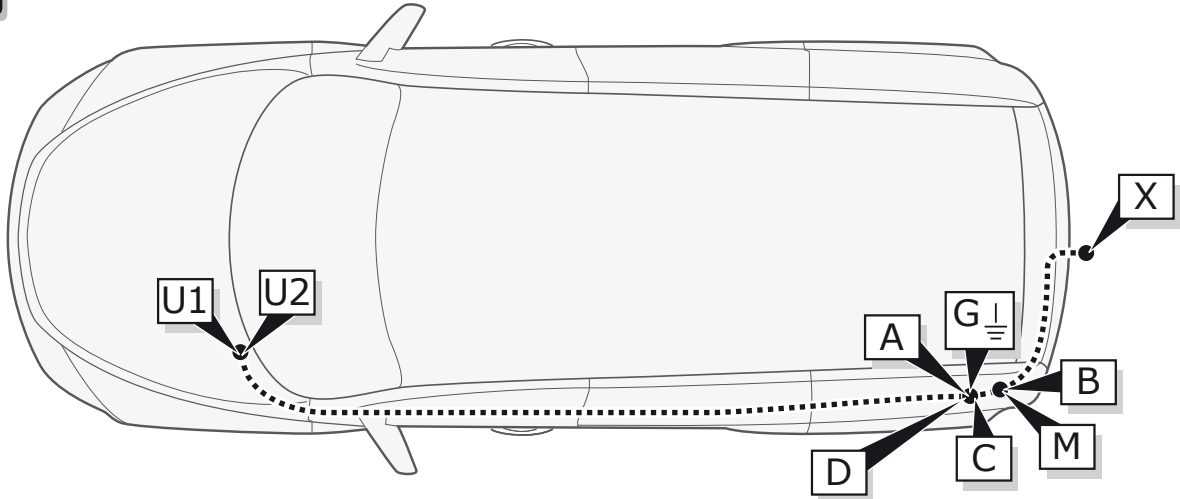

**1**

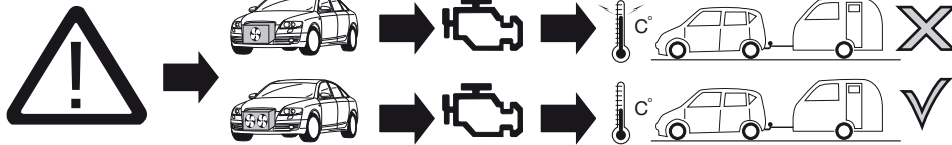

**ACHTUNG!**

DE

Die Kühlerleistung des Fahrzeuges muß bei Nachrüstung einer Anhängerkupplung möglicherweise erhöht werden! Bitte unbedingt Herstellerangaben beachten!!

**ATTENTION!**

FR

Il peut s'avérer nécessaire d'augmenter la puissance du radiateur du véhicule lorsque celui est équipé ultérieurement d'un attelage remorque! Respecter impérativement les instructions du constructeur!!

**ATTENTIE!**

NL

Het koelvermogen van het voertuig moet mogelijk worden verhoogd als achteraf een aanhangerkoppeling wordt aangebracht! Absoluut de fabrieksopgaven in acht nemen a.u.b.!!

**ATTENTION!**

GB

The vehicle's cooling capacity may have to be increased when retrofitting a trailer coupling! You must observe the manufacturer's instructions!!

**¡ATENCIÓN!**

ES

¡Es posible que haya que aumentar la capacidad del radiador en caso de reequipar un acoplamiento de remolque! ¡Rogamos tener en cuenta las instrucciones de fabricante sin falta!

**ATTENZIONE!**

IT

La capacità di raffreddamento del veicolo, quando si applica un gancio di traino, si deve possibilmente aumentare! Si prega di osservare tassativamente le indicazioni del produttore!!

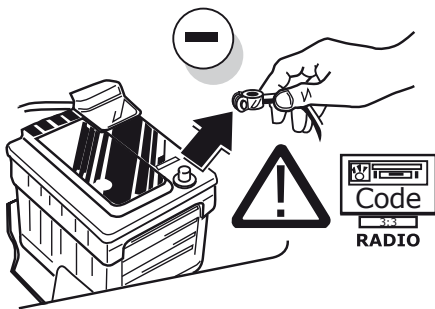

DE

Um Störungen und Schäden am Bordnetz zu vermeiden, muss die Massepolklemme unbedingt vor Beginn aller Arbeiten von der Fahrzeugbatterie getrennt werden! Insbesondere bei Arbeiten und Anschlüssen am CAN-Datenbus kann bei nicht abgeklemmter Batterie sowohl das Anhängermodul als auch das fahrzeugseitige Bordnetzsteuergerät beschädigt werden! Bitte Herstellervorschriften beim Ab- und Anklemmen der Fahrzeugbatterie beachten!

FR

Afin d'éviter tout dys-fonctionnement ou endom-magement du circuit de bord, il est indispensable de débrancher la pince de masse de la batterie du véhicule avant le début de toute opération! En particulier s'il s'agit de travaux et de branchements effectués sur le bus de données CAN, si la batterie n'est pas débranchée, le module remorque aussi bien que le dispositif de commande de circuit de bord du véhicule risquent d'être endommagés! Veuillez respecter les directives du fabricant lors du branchement et du débranchement de la batterie du véhicule!

NL

Om storingen en schade aan de elektrische bedrading te vermijden moet de massapoolklem absoluut vóór aanvang van alle werkzaamheden worden losgekoppeld van de voertuigaccu! Vooral bij werkzaamheden aan en aansluitingen op de CAN-databus kan zowel de aanhangermodule als de voertuigzijdige regeleenheid voor de elektrische installatie beschadigd worden, als de accu niet ontkoppeld is! Fabrieksvoorschriften bij het vast- en loskoppelen van de voertuigaccu in acht nemen a.u.b.!

GB

In order to avoid mal-functions and damage to the vehicle's electrical system the earth terminal must be disconnected from the vehicle's battery before starting work! Both the trailer module and the vehicle's control unit for the electrical system can be damaged during work on the CAN data bus connections if the battery is not disconnected! Please pay attention to the manufacturer's instructions when disconnecting and reconnecting the vehicle's battery!

ES

¡Para evitar fallos y defectos en el sistema eléctrico de a bordo es imprescindible separar al terminal de puesta a tierra de la batería del vehículo antes de realizar cualquier trabajo! ¡Particularmente al realizar trabajos y conexiones al bus de datos CAN puede estropearse tanto el módulo para remolques como el regulador del sistema eléctrico de a bordo del vehículo si no se ha desconectado la batería! ¡Rogamos observar las instrucciones del fabricante al conectar y desconectar la batería del vehículo!

IT

Per evitare disturbi e danni alla rete di distribuzione elettrica, l'espansione polare a massa deve essere assolutamente scollegata dalla batteria del veicolo prima dell'inizio dei lavori! In particolare durante i lavori e gli allacciamenti al bus di dati CAN, se la batteria non è scollegata si possono danneggiare sia la centralina rimorchio, sia la centralina della rete di distribuzione elettrica del veicolo! Attenersi alle indicazioni del costruttore per scollegare e ricollegare la batteria del veicolo!

2

**BYD Seal**

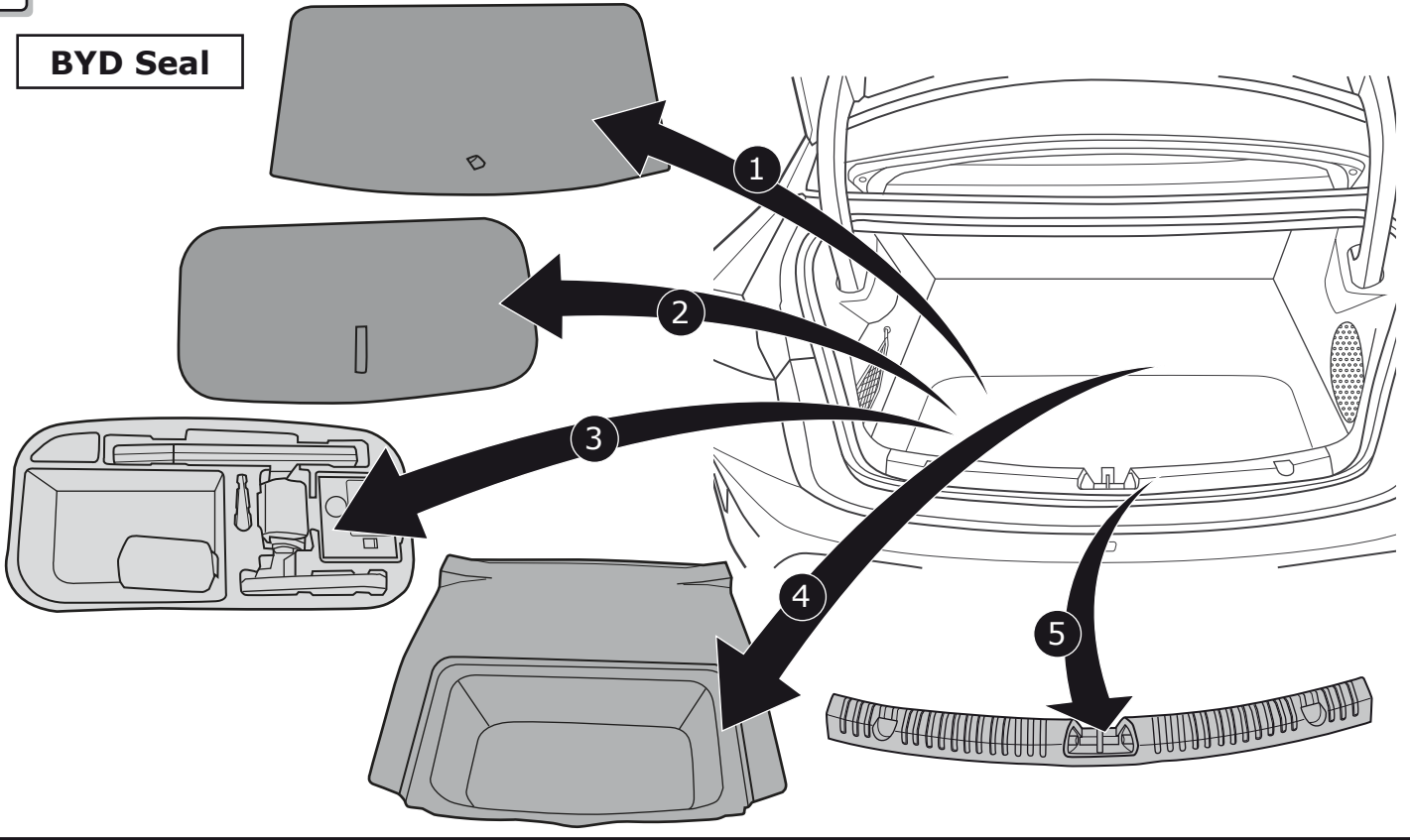

3

**BYD Seal**

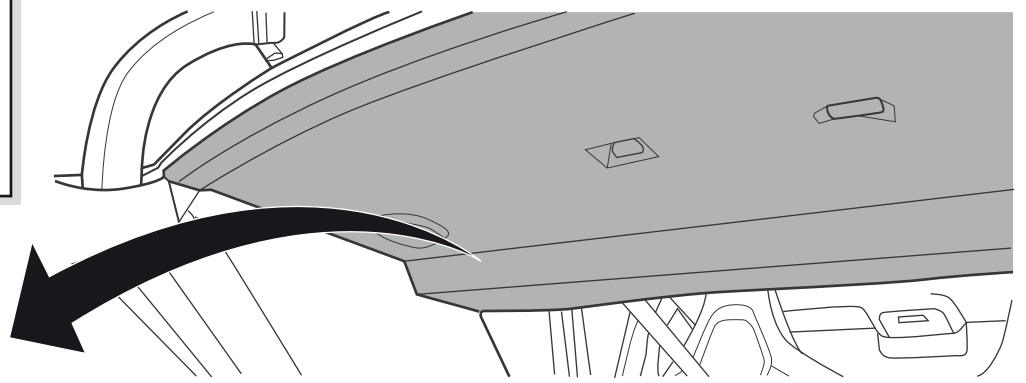
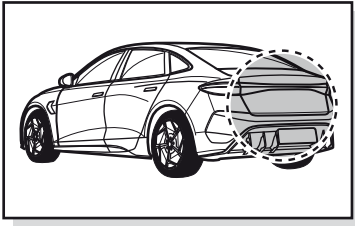

4

**BYD Seal**

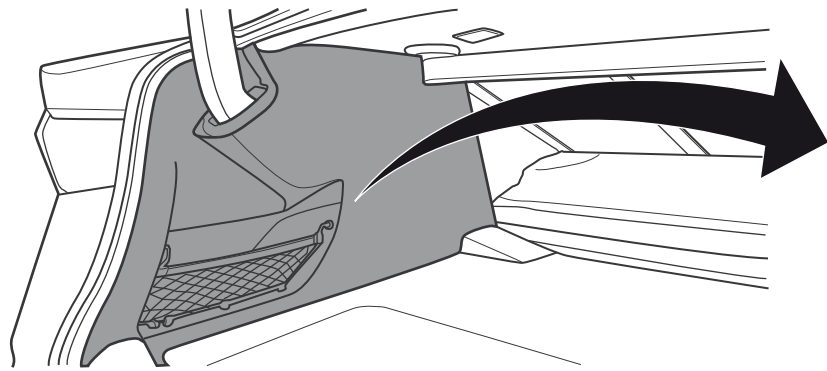
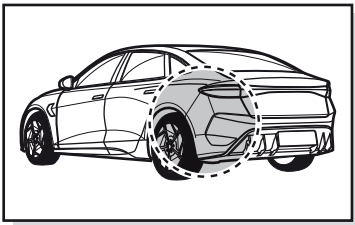

5

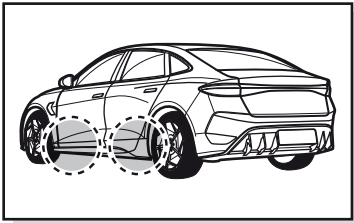

**BYD Seal**

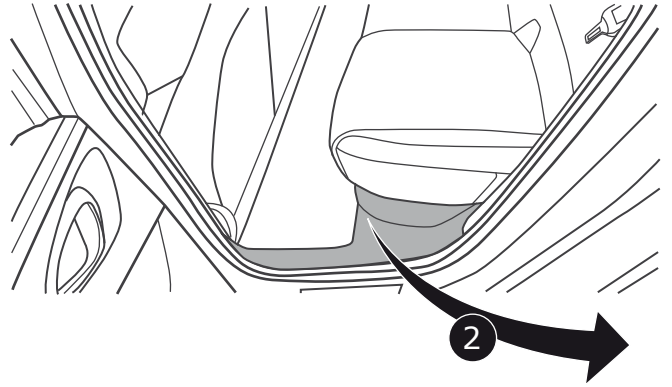
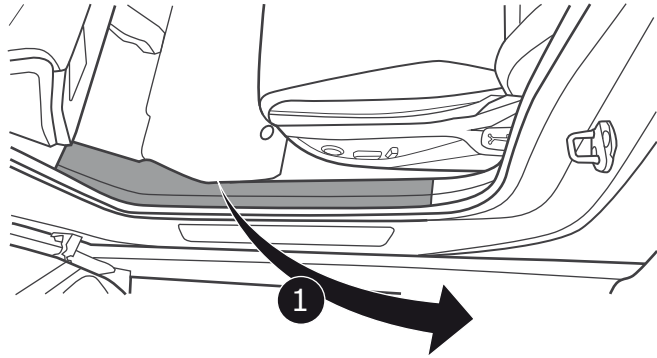

6

**BYD Seal U**

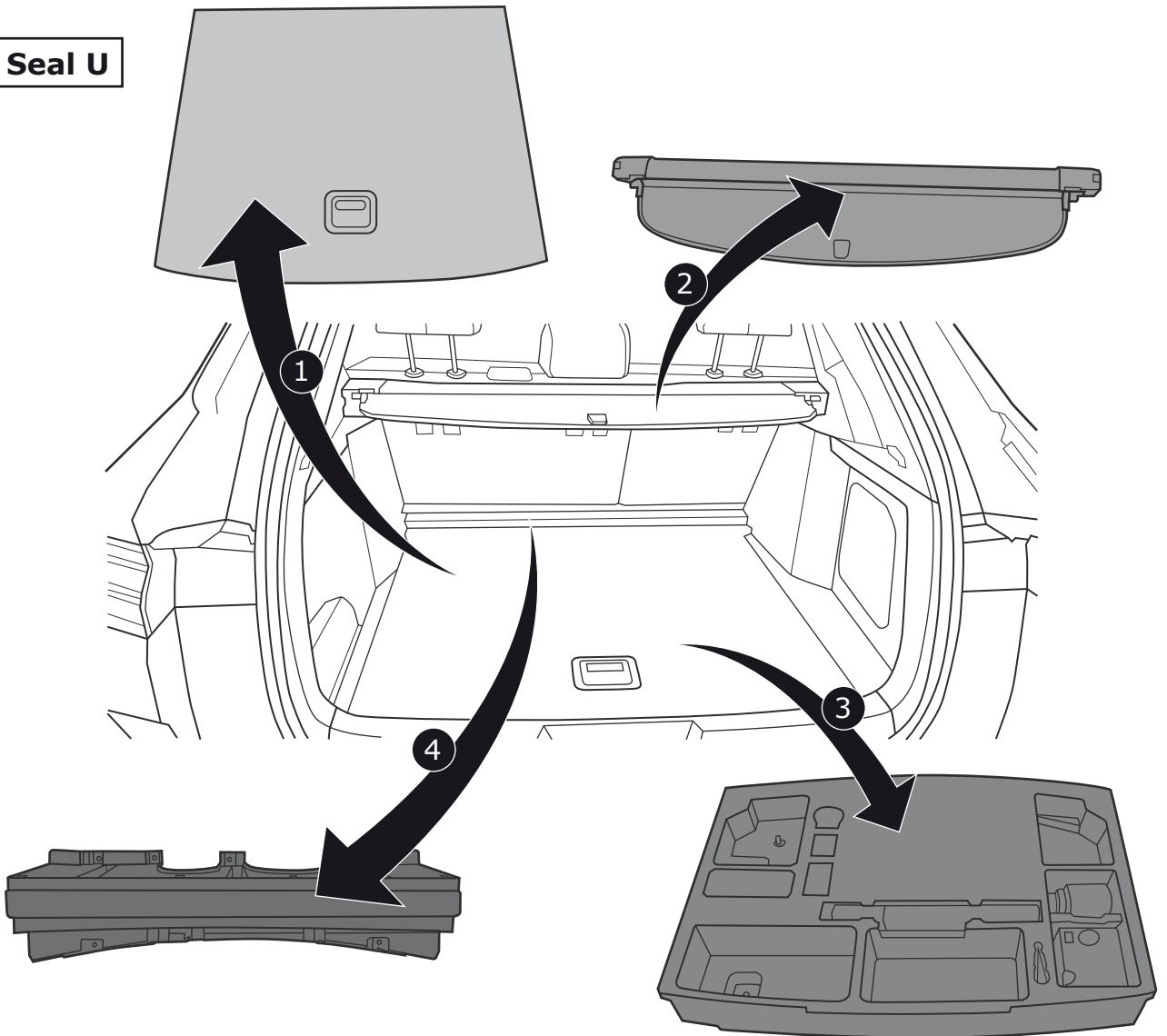

7

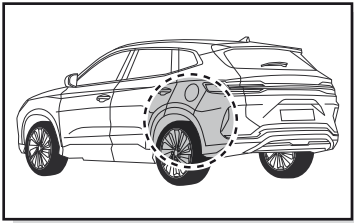

**BYD Seal U**

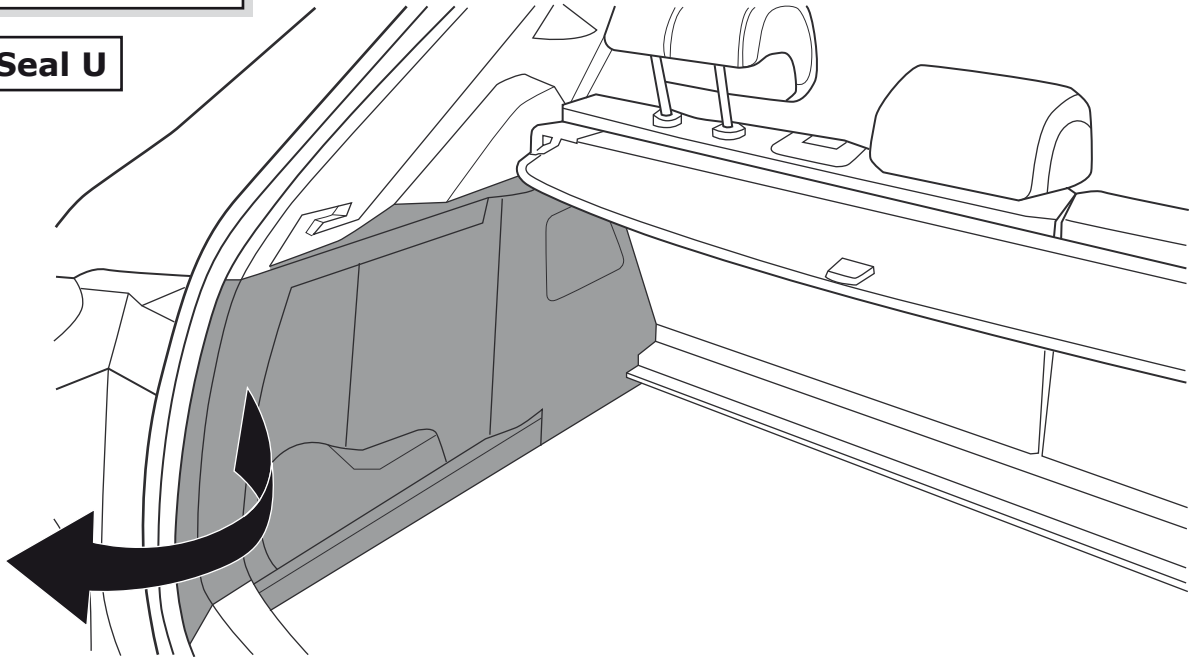

8

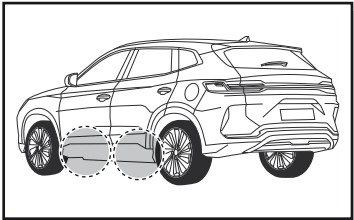

**BYD Seal U**

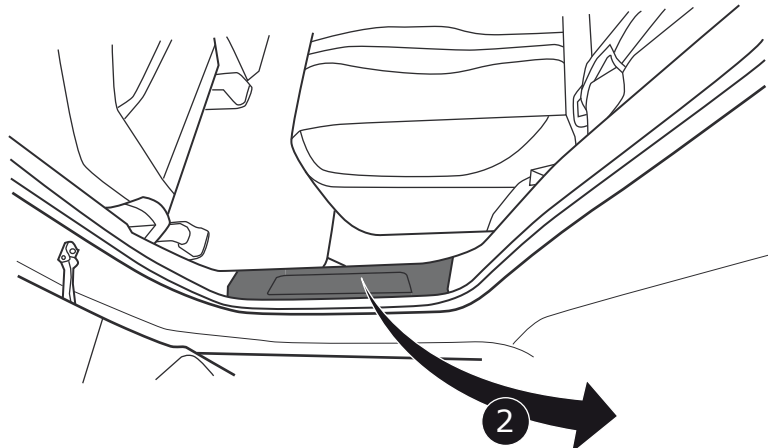
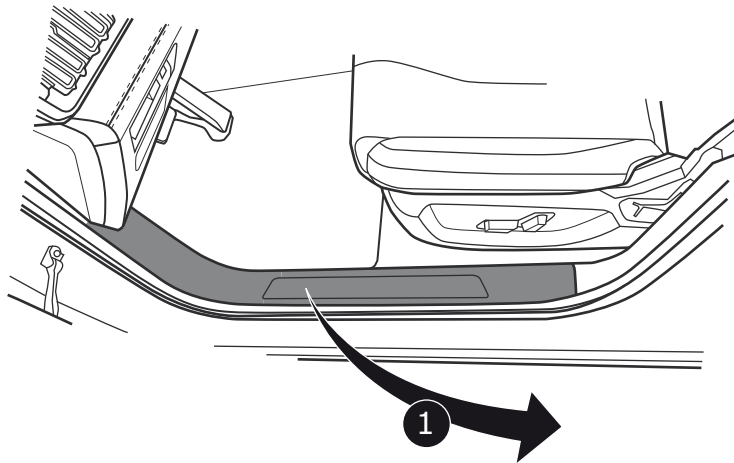

**BYD SeaLion 7**

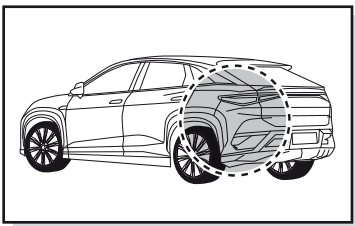
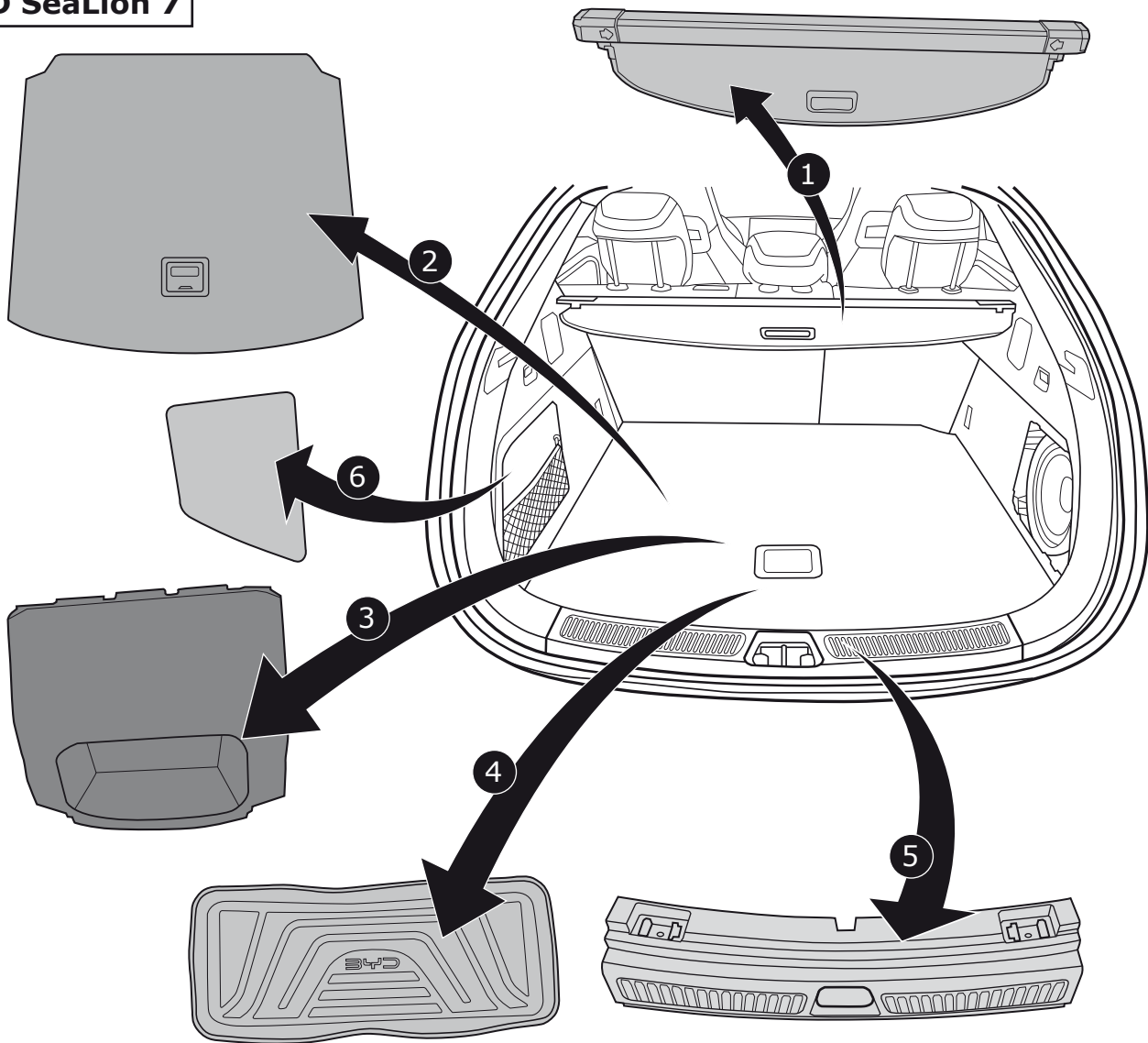

**BYD SeaLion 7**

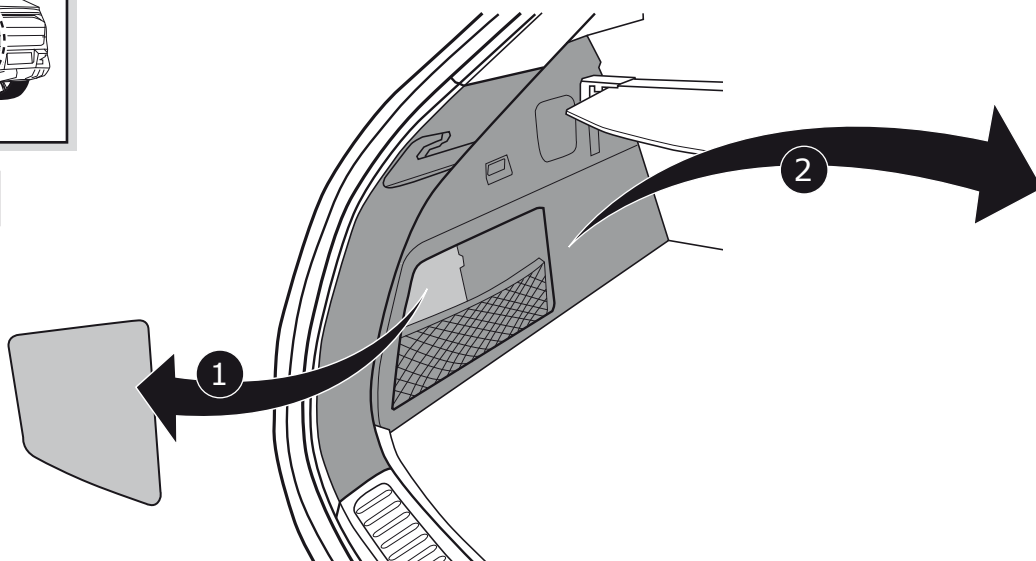

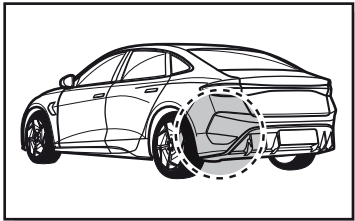

**BYD Seal**

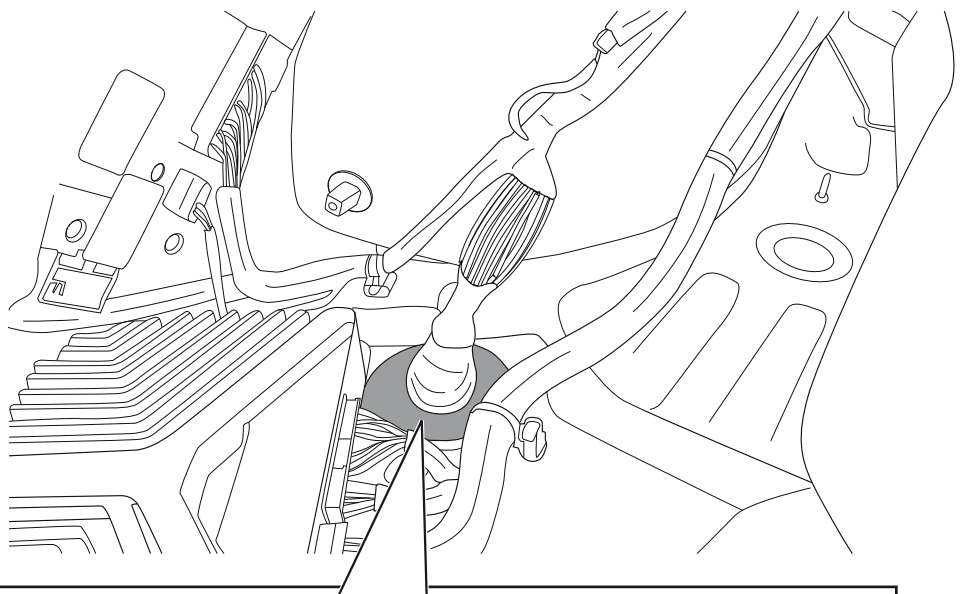

(DE) Klebeband entfernen  
 (FR) Enlevez Ruban adhésif  
 (NL) Tape verwijderen  
 (GB) Remove tape  
 (ES) Retirar la cinta adhesiva  
 (IT) Rimuovere il nastro adesivo

**1**

---

X

**2**

**3**

---

X

**4**

**SEAL WITH SILICONE.**

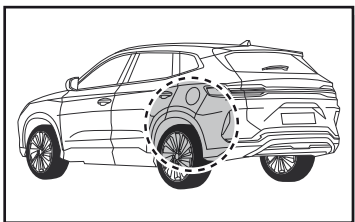

**BYD Seal U**

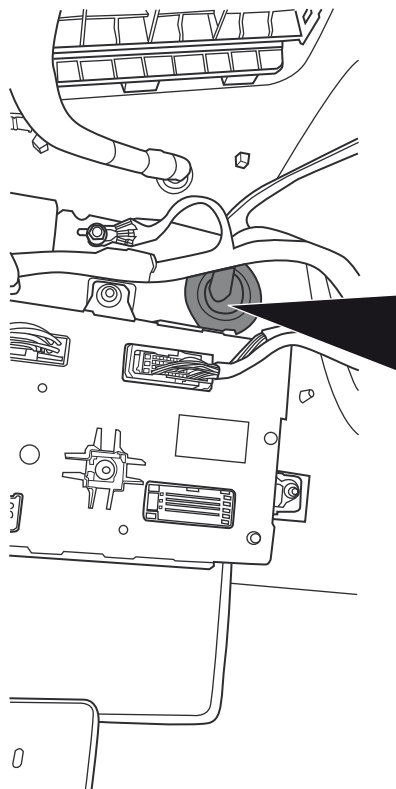
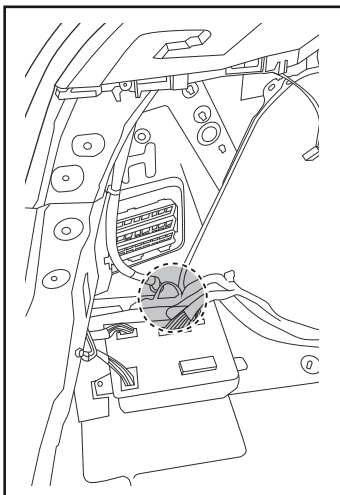

(DE) Klebeband entfernen  
 (FR) Enlevez Ruban adhésif  
 (NL) Tape verwijderen  
 (GB) Remove tape  
 (ES) Retirar la cinta adhesiva  
 (IT) Rimuovere il nastro adesivo

**1**

---

X

**2**

**3**

---

X

**4**

**SEAL WITH SILICONE.**

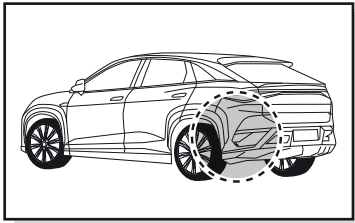

**BYD SeaLion 7**

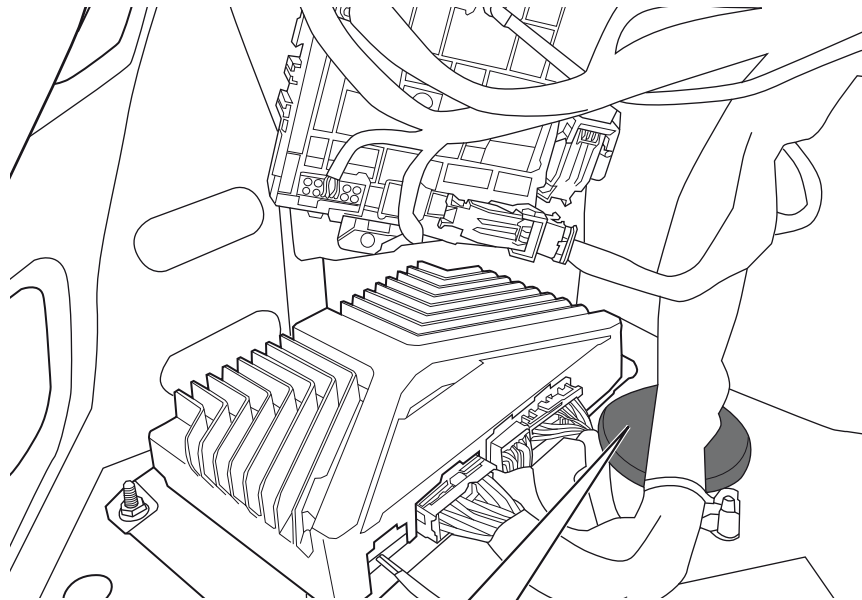

(DE) Klebeband entfernen  
 (FR) Enlevez Ruban adhésif  
 (NL) Tape verwijderen  
 (GB) Remove tape  
 (ES) Retirar la cinta adhesiva  
 (IT) Rimuovere il nastro adesivo

**A**

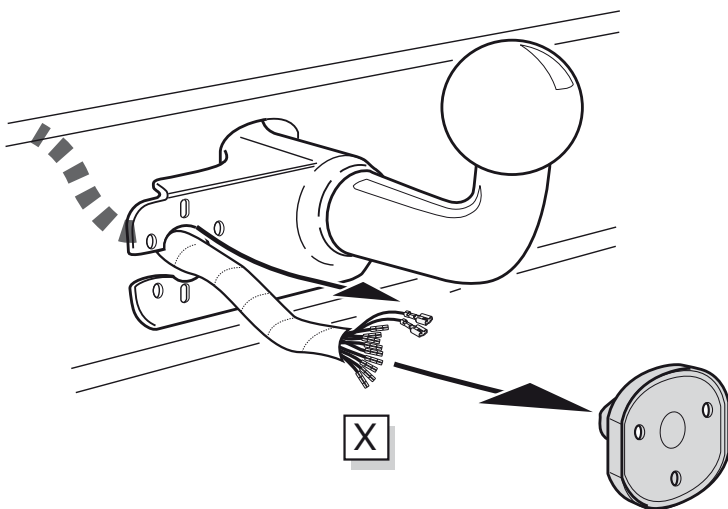

**INFO**

- (DE) Anschluss Steckdose
- (FR) Connection de la prise
- (NL) Contactdoos aansluiting
- (GB) Socket connection
- (ES) Conexión de la caja de enchufe
- (IT) Allaccio zoccolo



**Page 32**

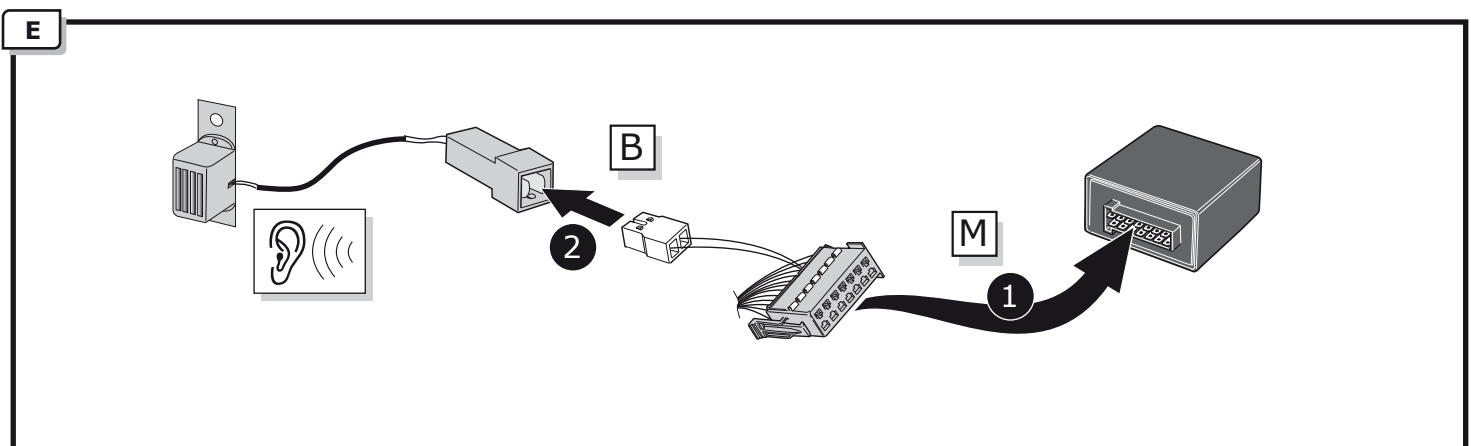
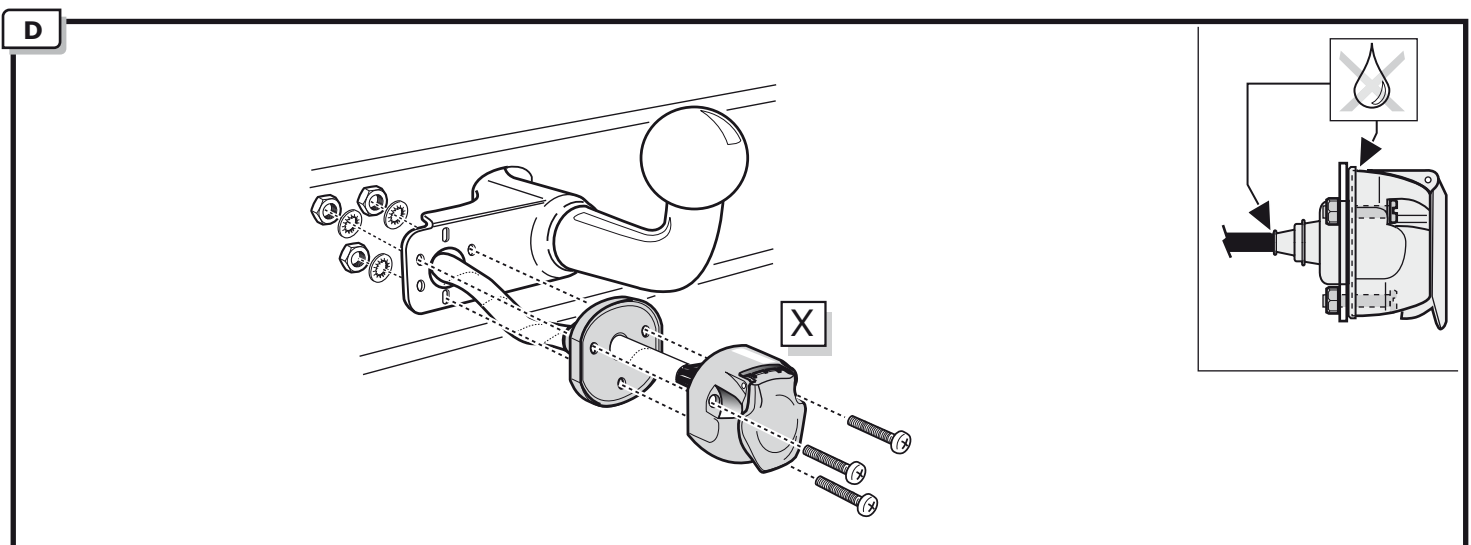
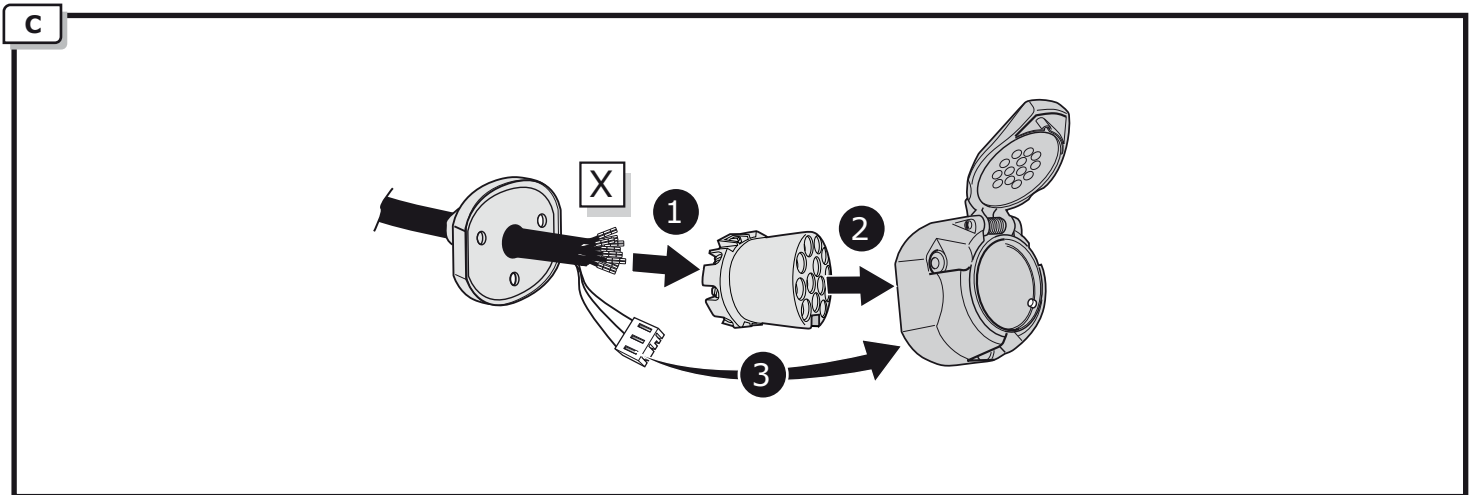
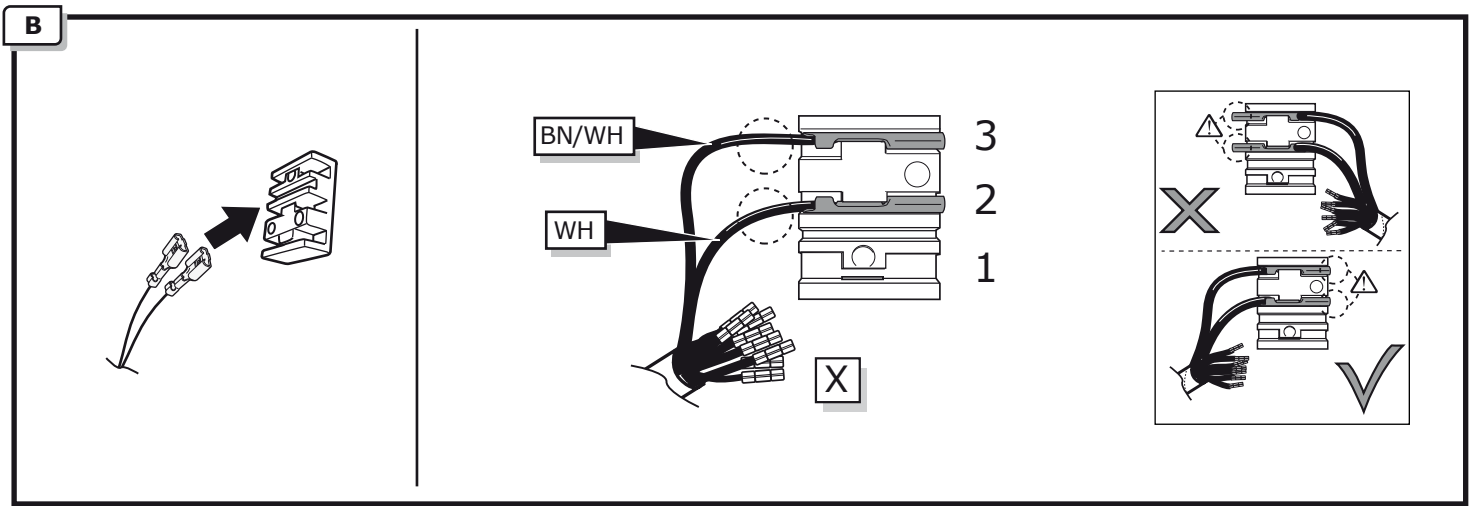

14

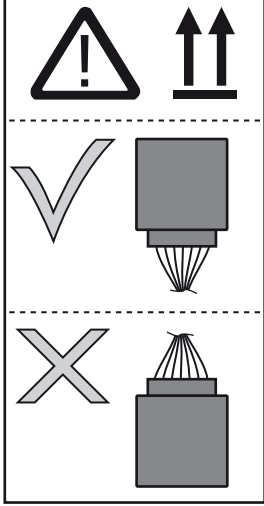
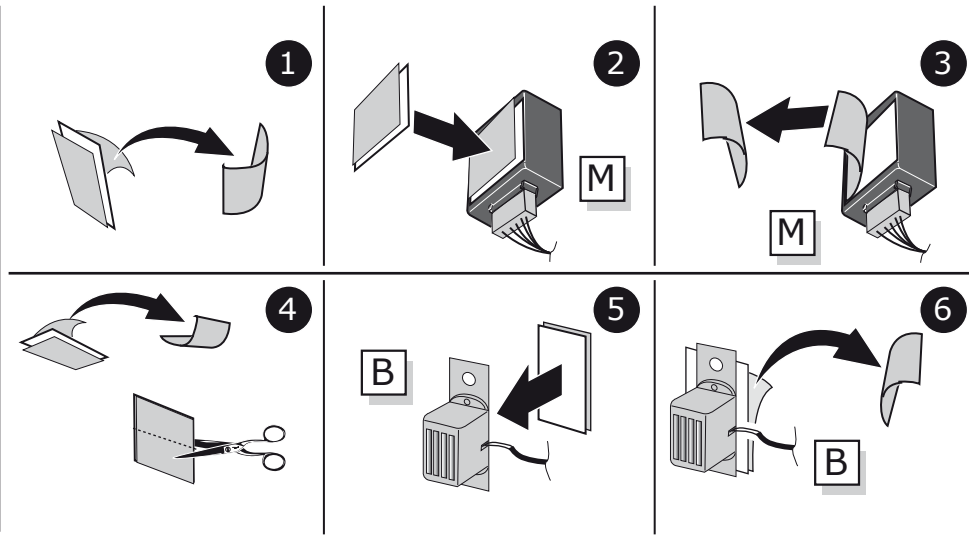
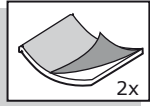

15

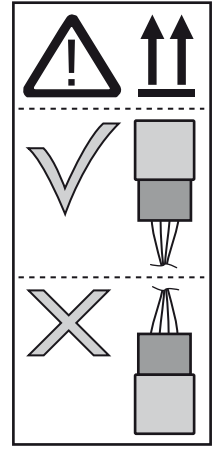
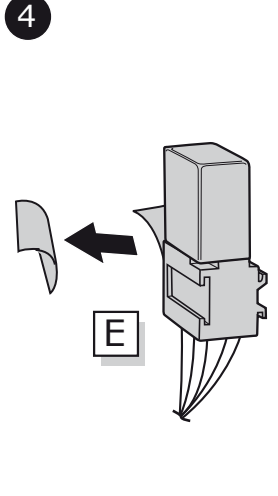
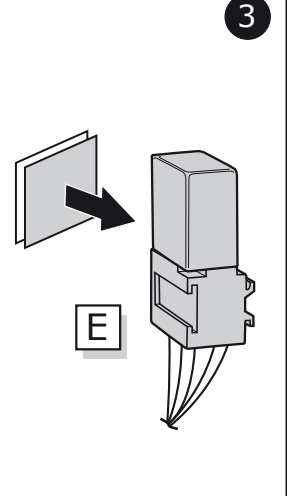
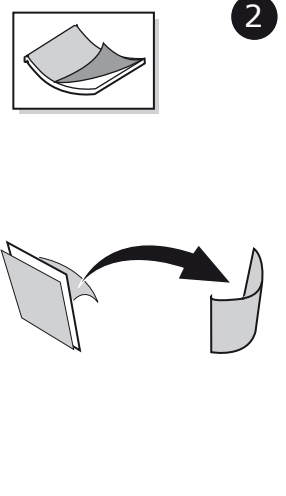
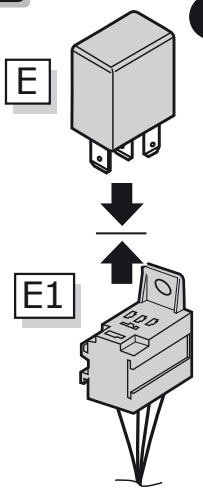

16

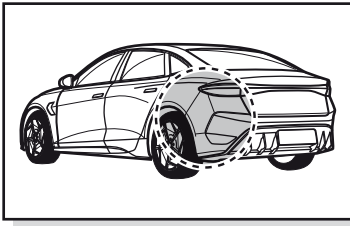

**BYD Seal**

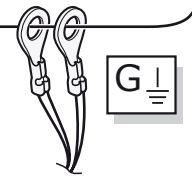
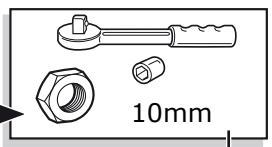
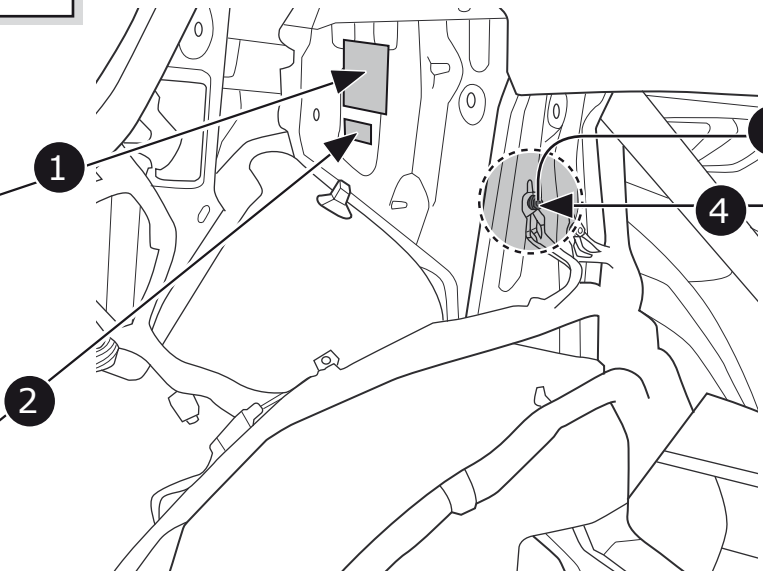
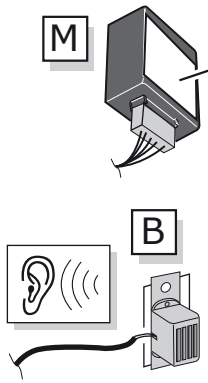

**G**

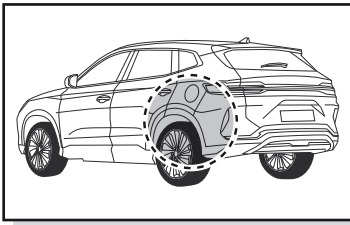

**BYD Seal U**

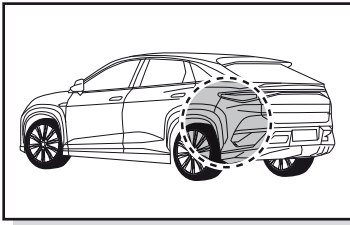
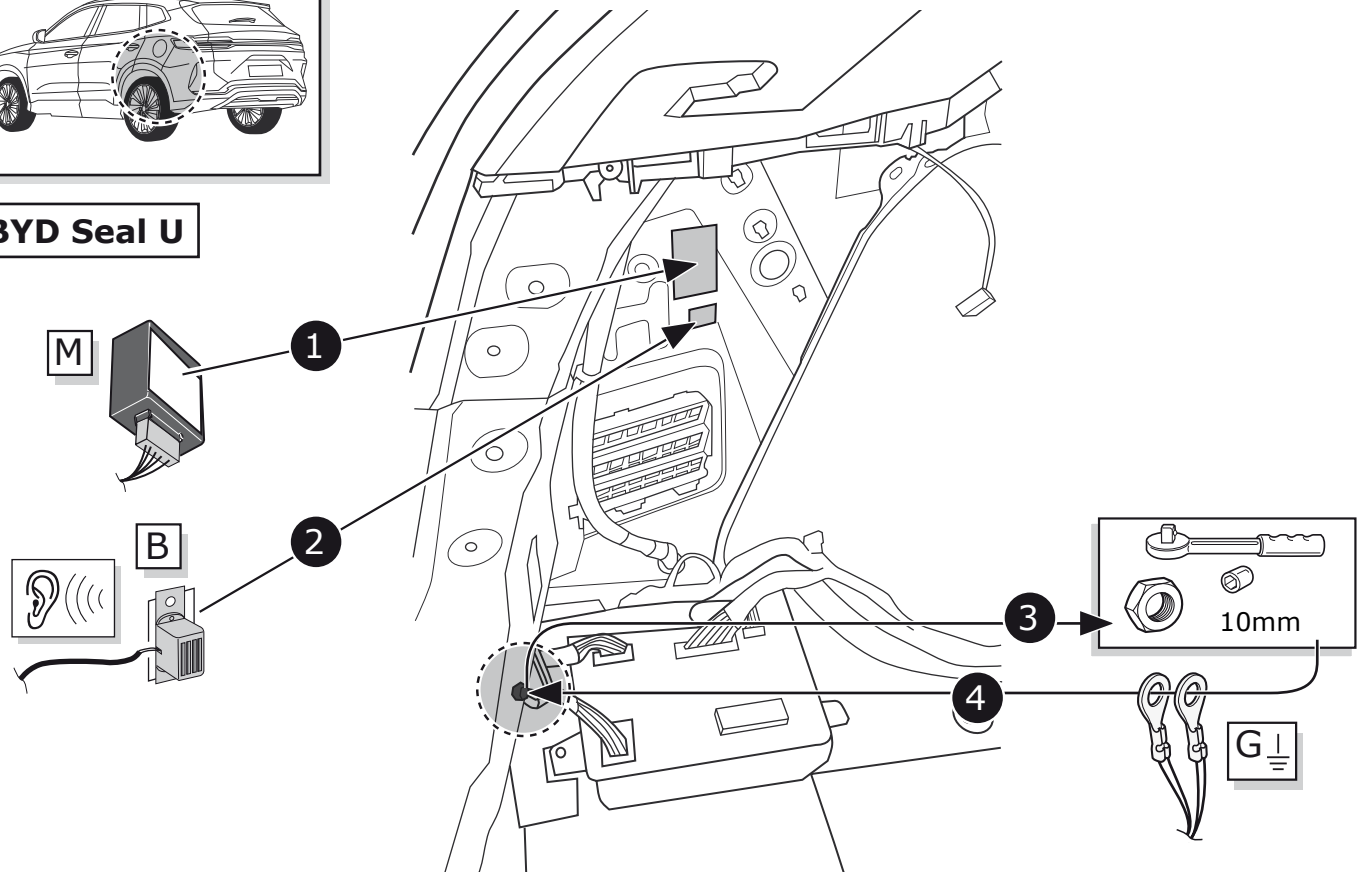

**BYD SeaLion 7**

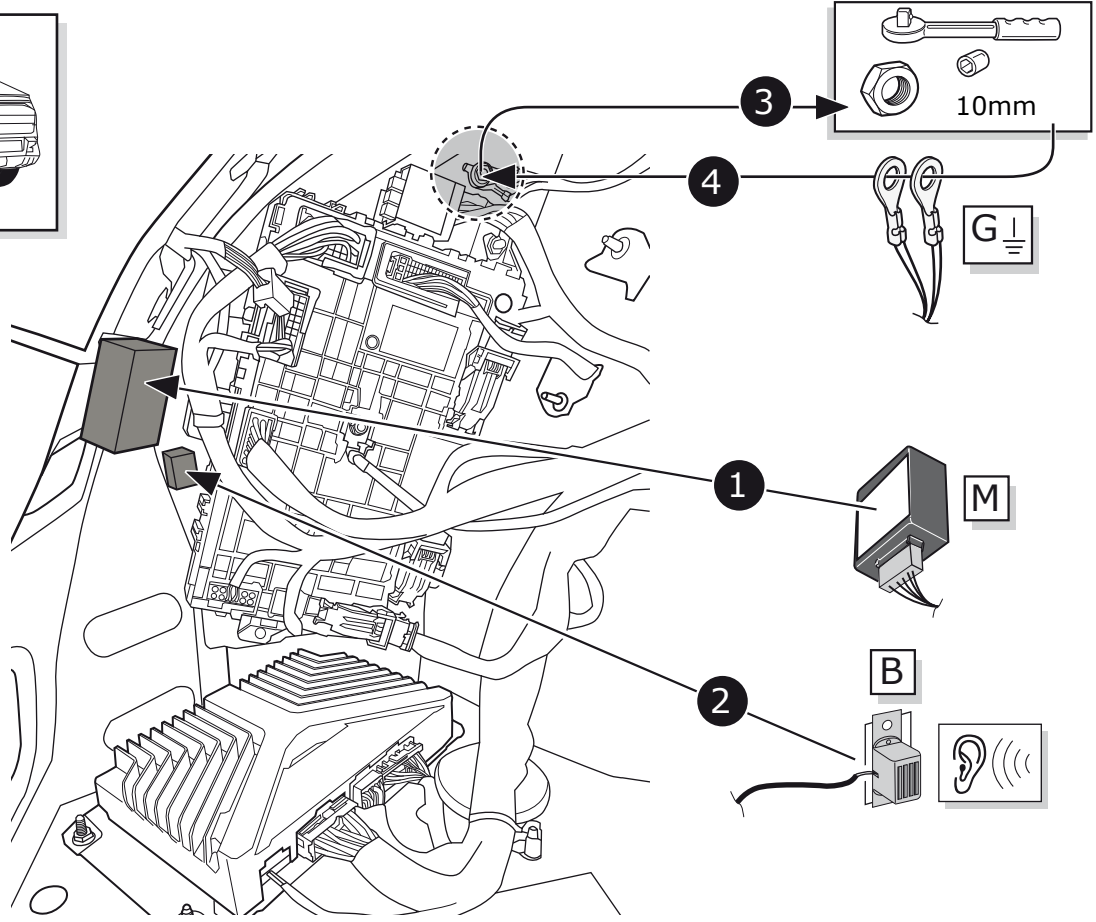

### BYD Seal

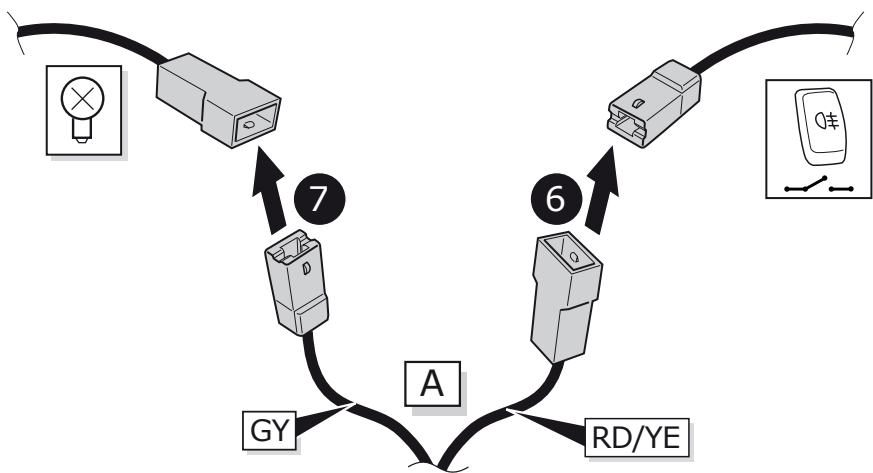
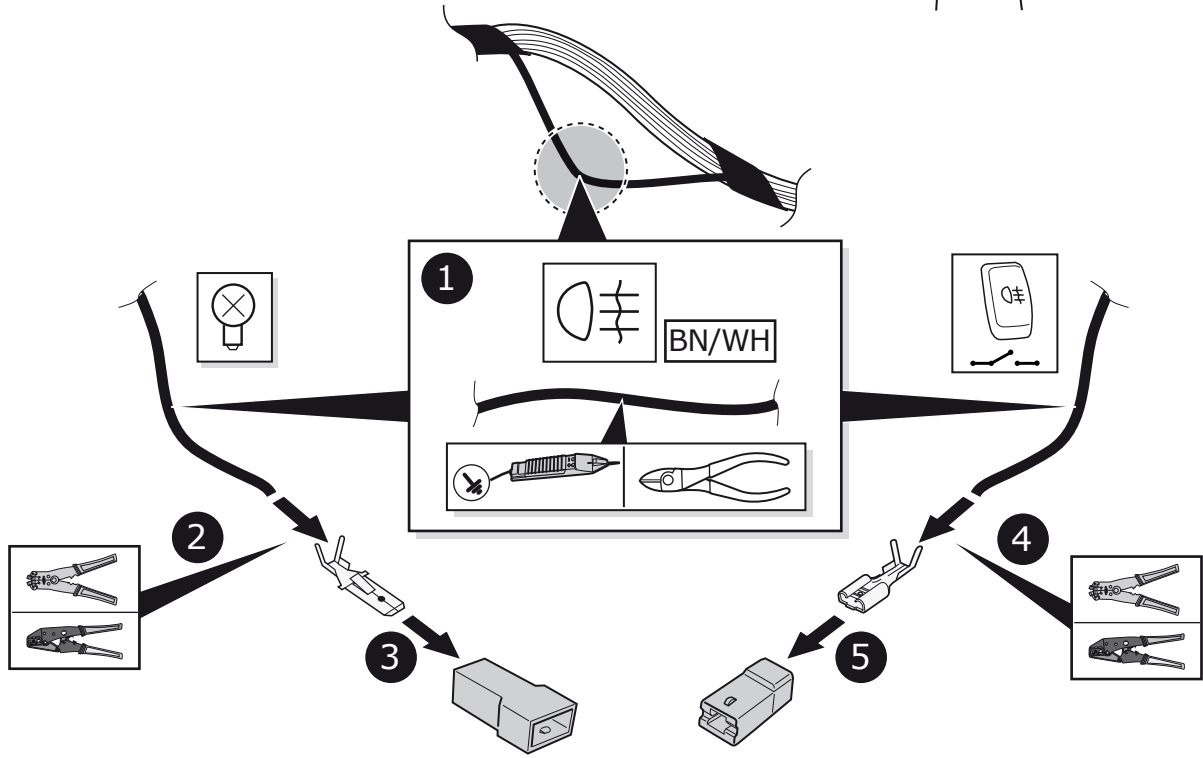
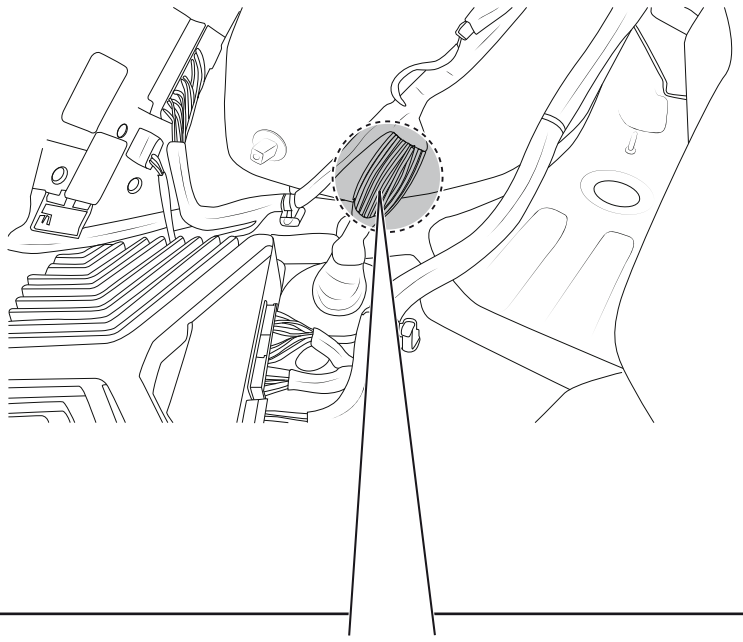
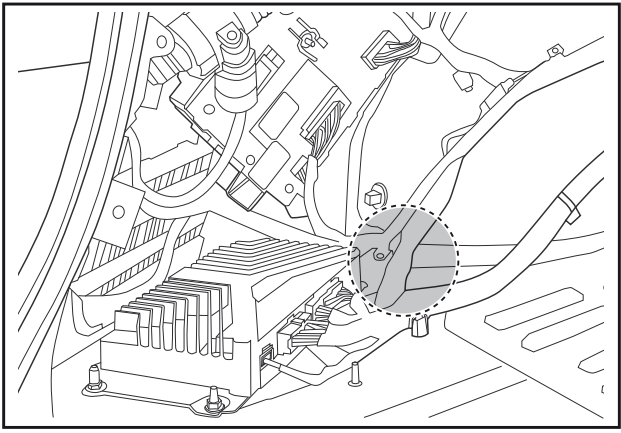
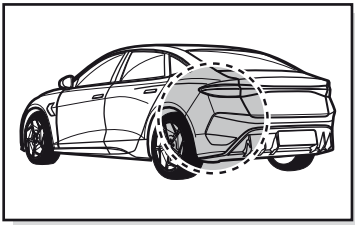

### BYD Seal U

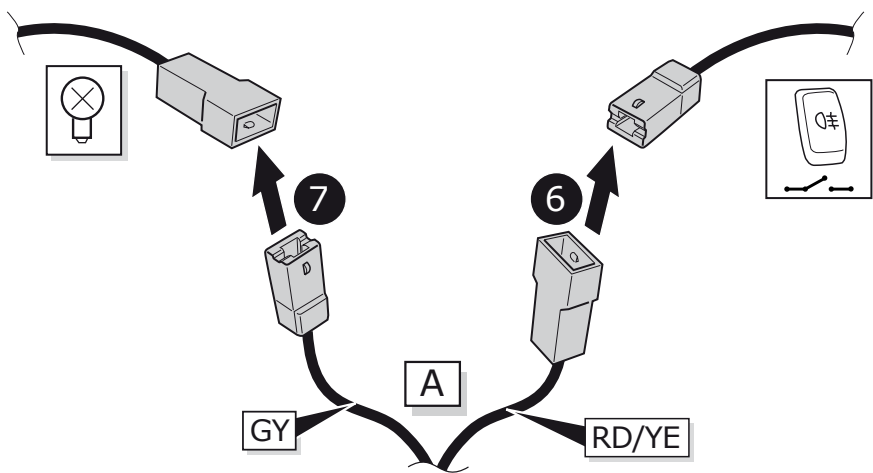
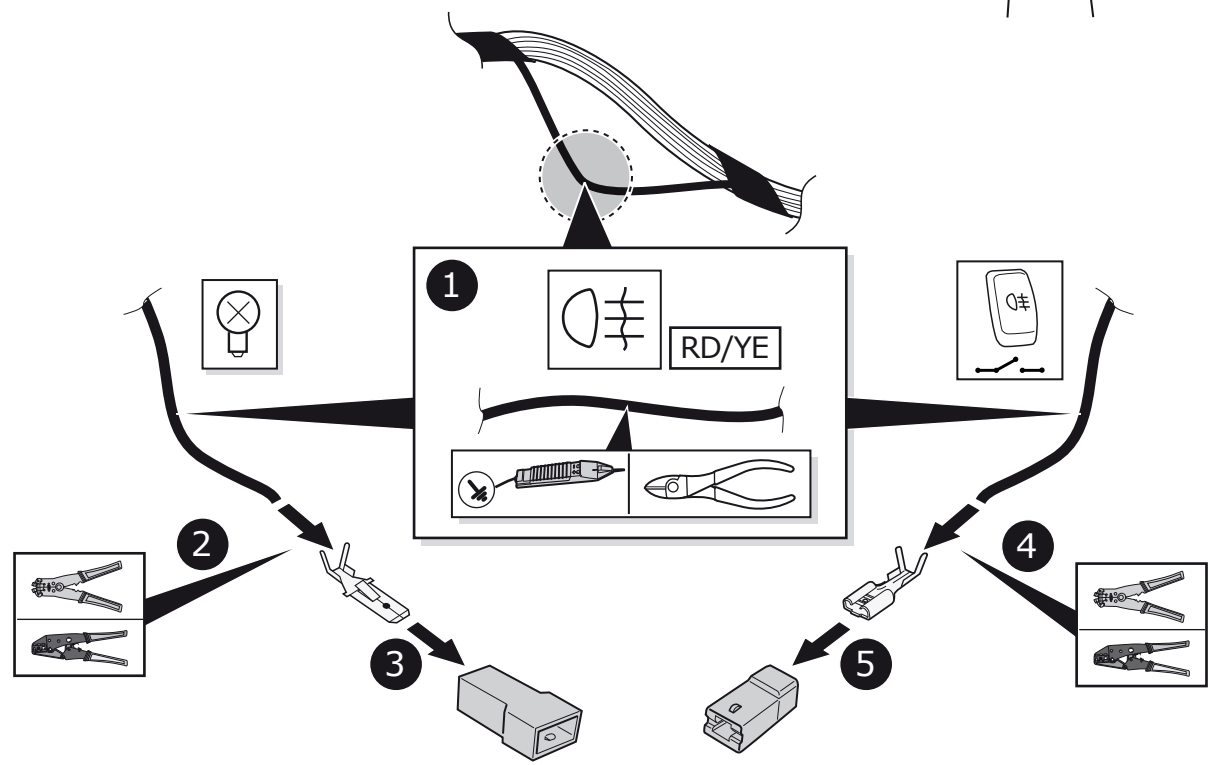
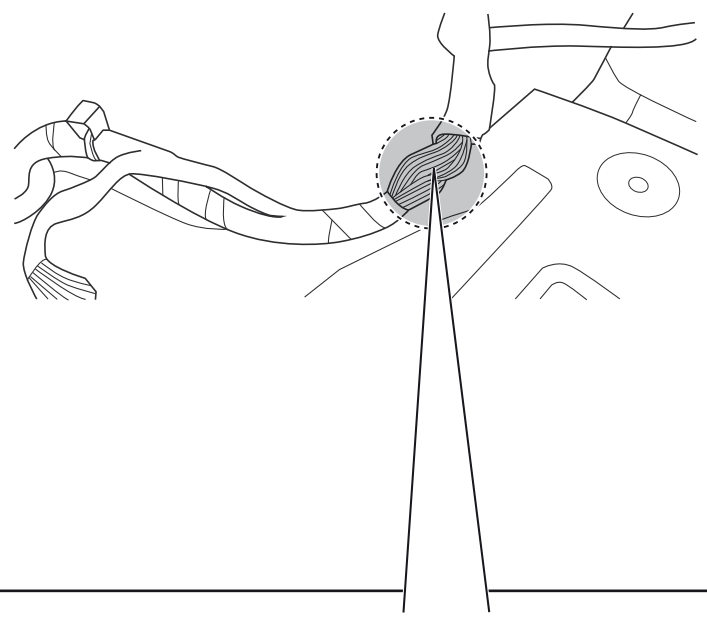
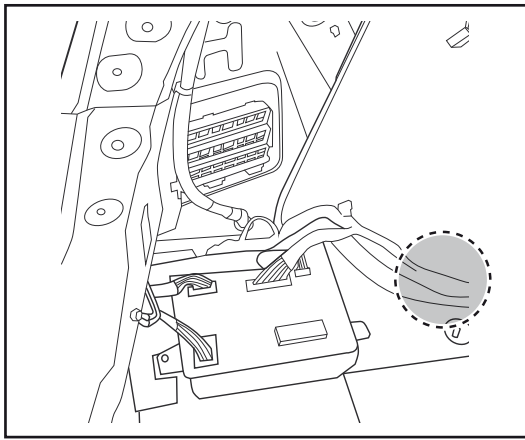
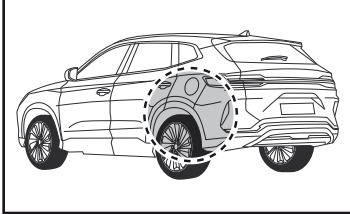

# BYD SeaLion 7

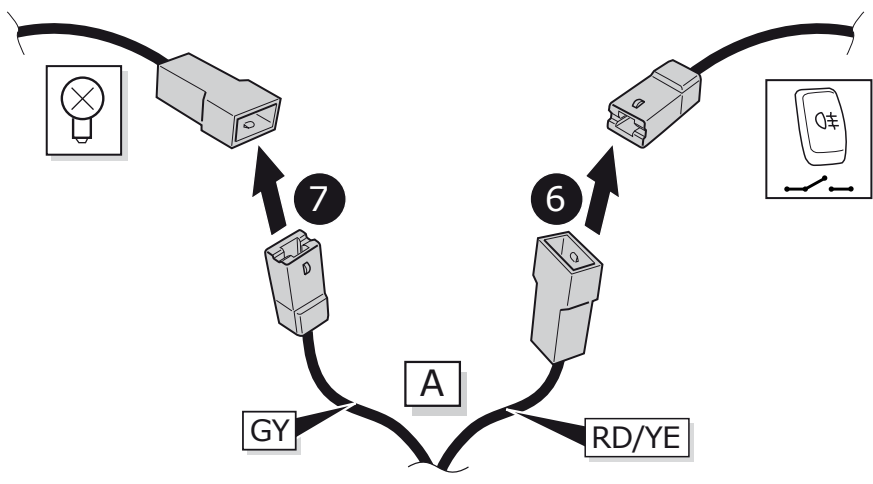
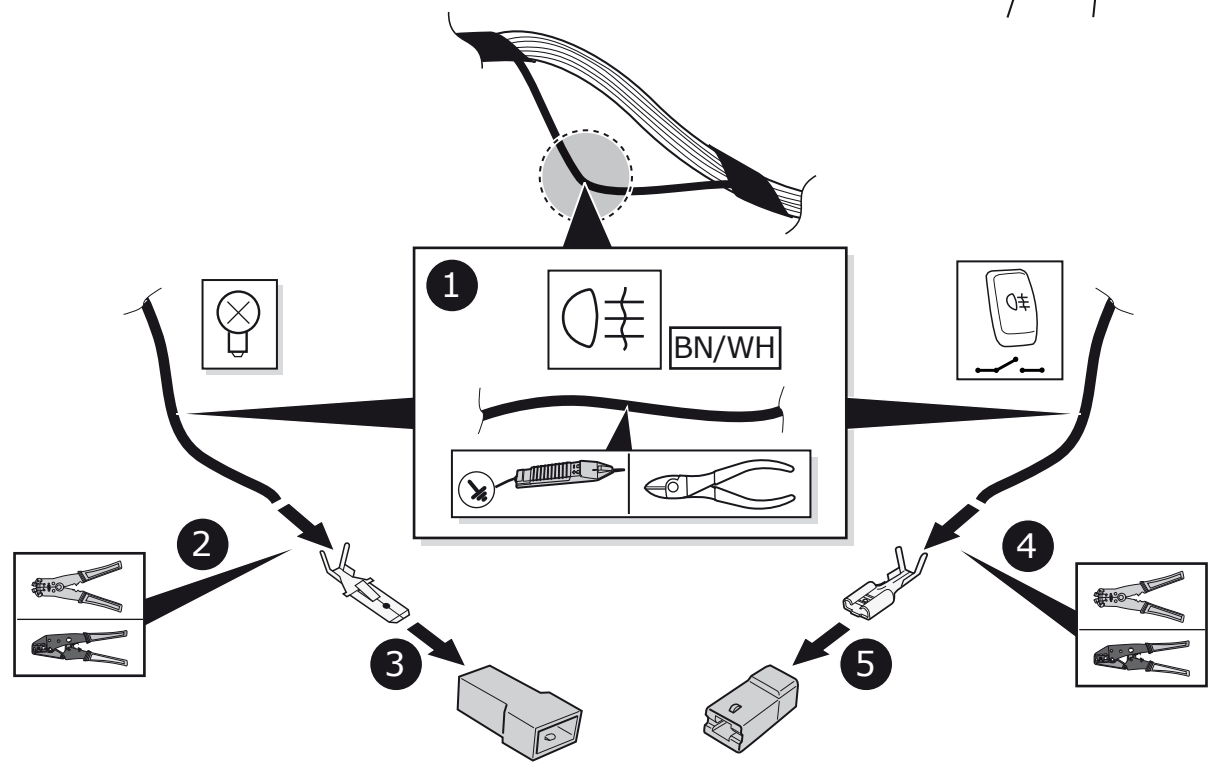
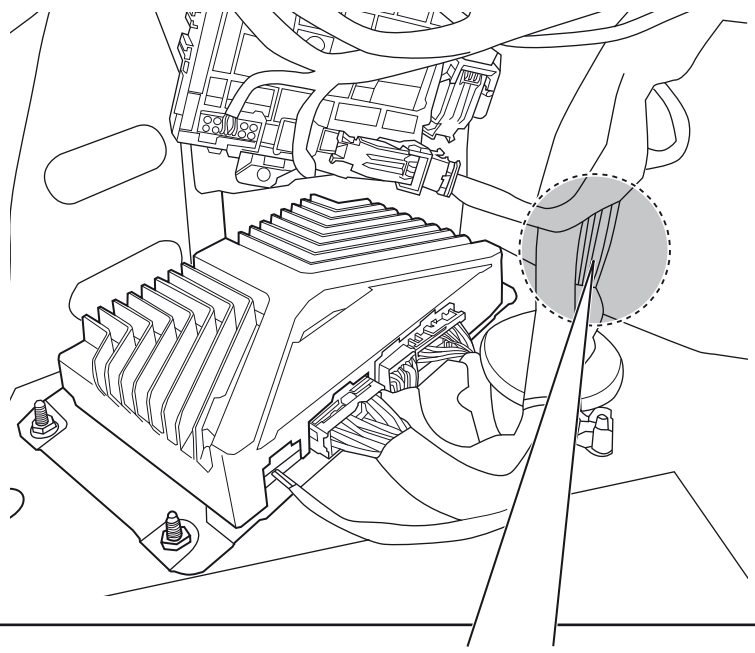
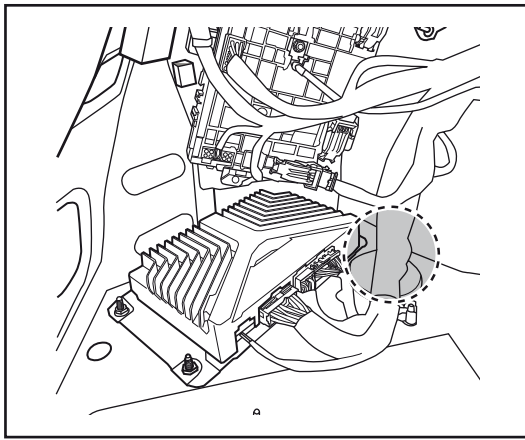
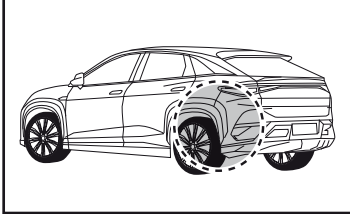

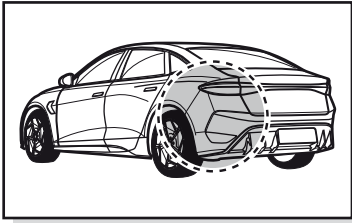

**CAN-Data Wire**

PE	= CAN Low
PI	= CAN High

**BYD Seal**

Cut to length!



1

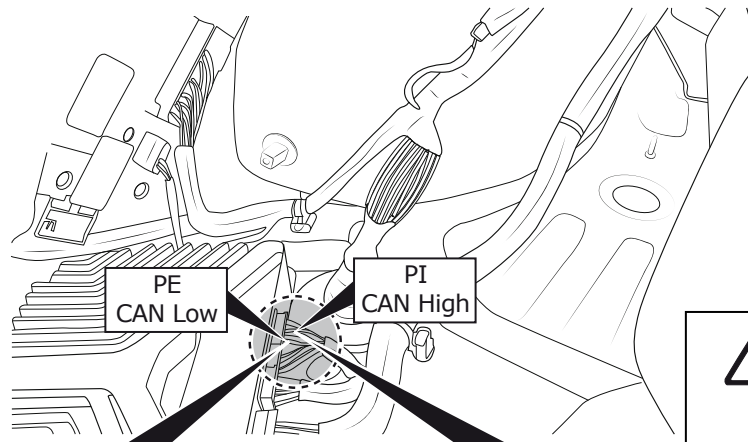
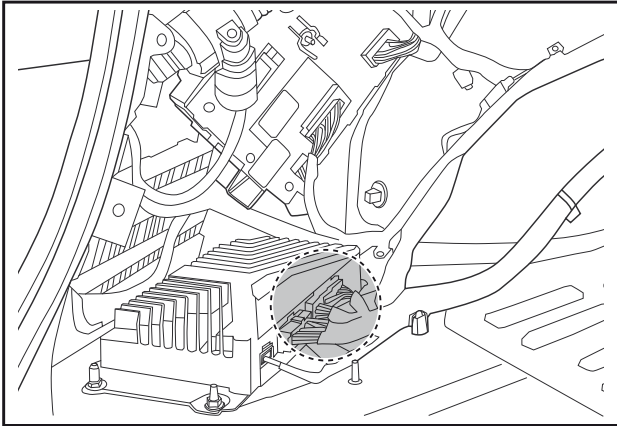
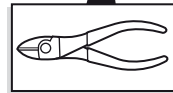

2

3

Please note different wire-size slots in CANbus connector!

0.5-0.75 mm<sup>2</sup>  
0.35 mm<sup>2</sup>

PE  
YE  
C

Please note different wire-size slots in CANbus connector!

0.5-0.75 mm<sup>2</sup>  
0.35 mm<sup>2</sup>

PI  
BK  
C

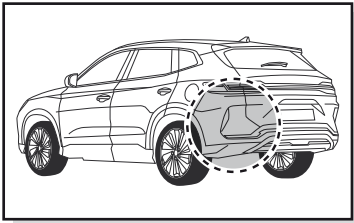

**CAN-Data Wire**

PE = CAN Low	
PI = CAN High	

**BYD Seal U**

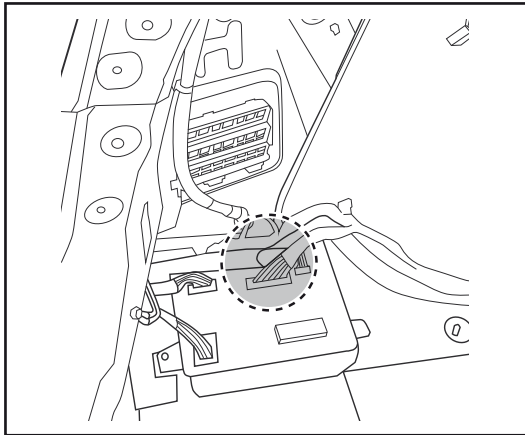

Cut to length!

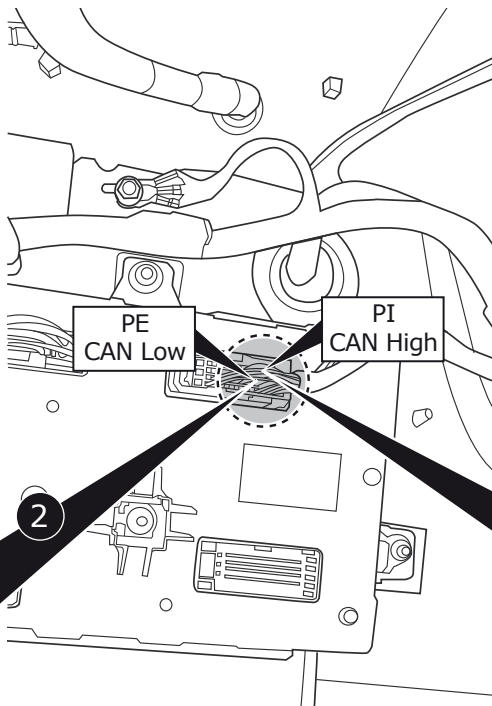
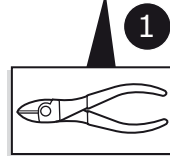

Please note different wire-size slots in CANbus connector!

0.5-0.75 mm<sup>2</sup>

0.35 mm<sup>2</sup>

PE

YE

C

Please note different wire-size slots in CANbus connector!

0.5-0.75 mm<sup>2</sup>

0.35 mm<sup>2</sup>

PI

BK

C

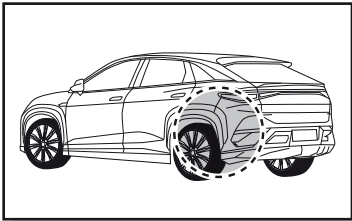

**CAN-Data Wire**

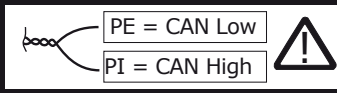

**BYD SeaLion 7**

Cut to length!

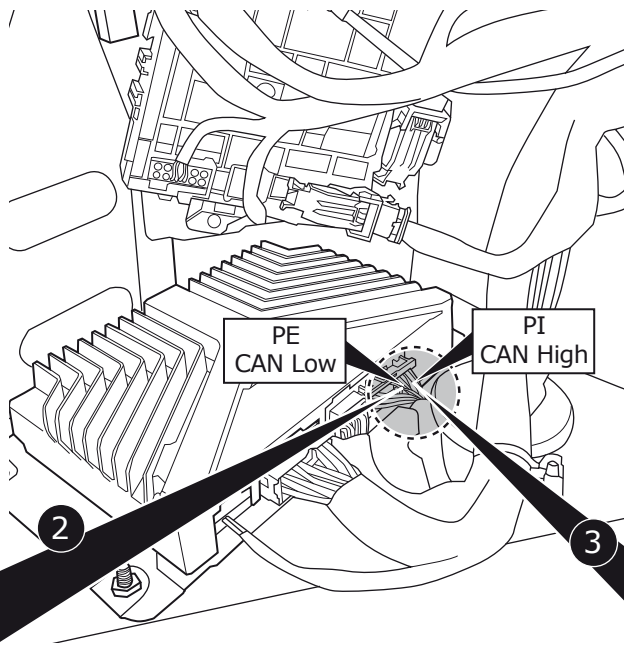
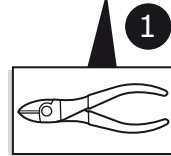
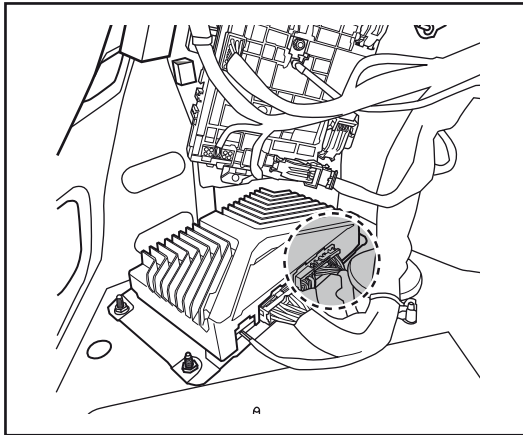

**⚠ Please note different wire-size slots in CANbus connector!**

PE  
YE  
C

PI  
BK  
C

**⚠ Please note different wire-size slots in CANbus connector!**

PI  
BK  
C

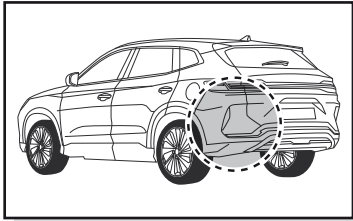

**BYD Seal U**

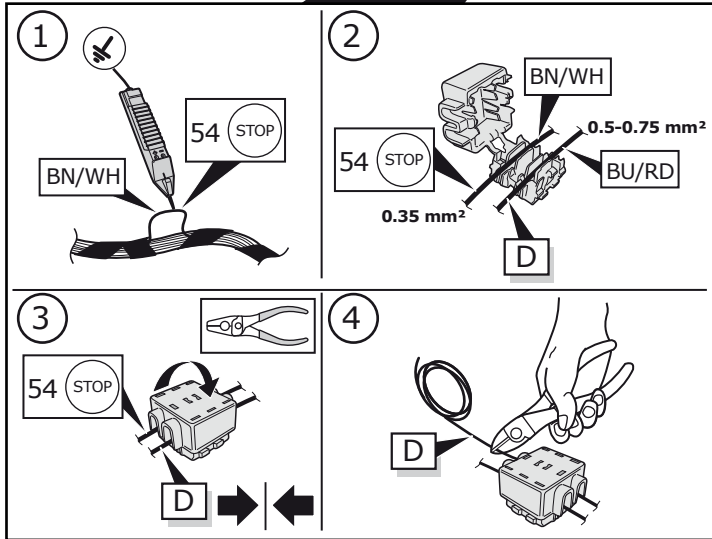
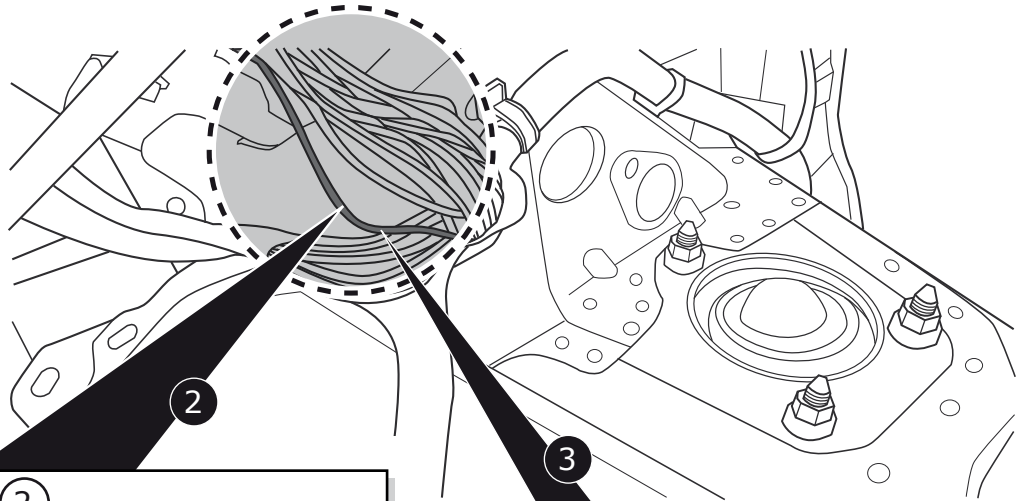

- DE Klebeband entfernen
- FR Enlevez Ruban adhésif
- NL Tape verwijderen
- GB Remove tape
- ES Retirar la cinta adhesiva
- IT Rimuovere il nastro adesivo

Cut to length!

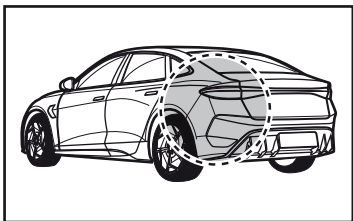
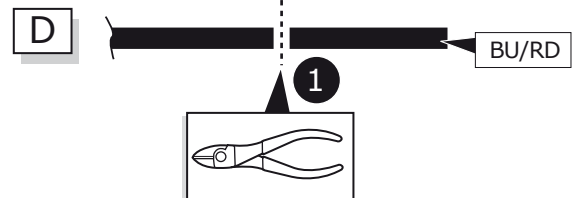

**BYD Seal**

- DE Klebeband entfernen
- FR Enlevez Ruban adhésif
- NL Tape verwijderen
- GB Remove tape
- ES Retirar la cinta adhesiva
- IT Rimuovere il nastro adesivo

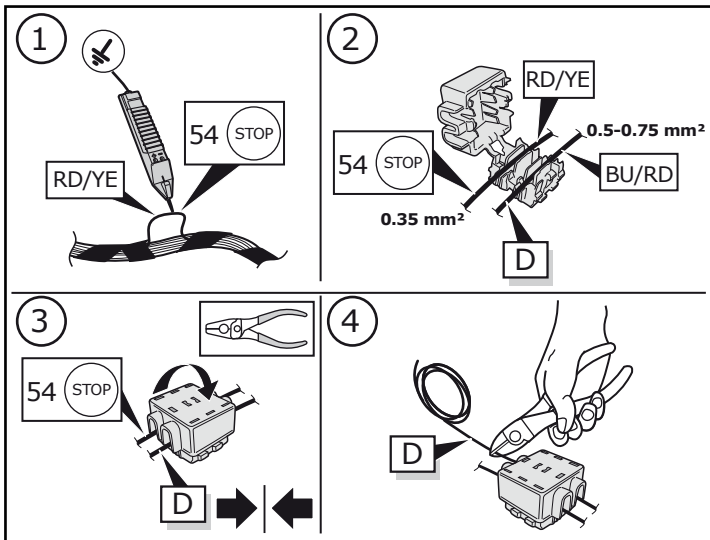

Cut to length!

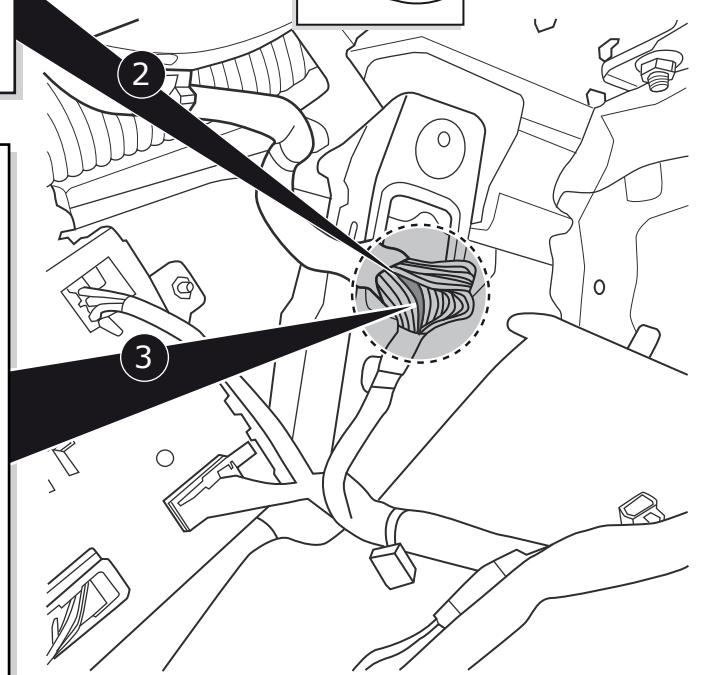
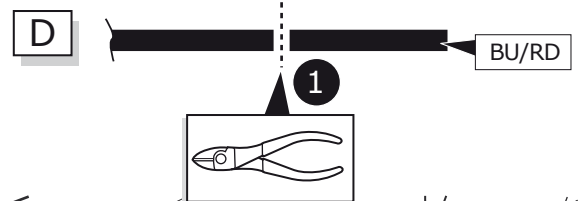

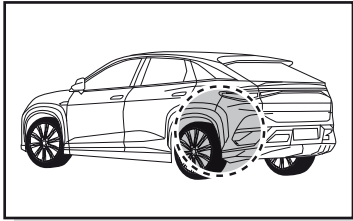

**BYD SeaLion 7**

Cut to length!

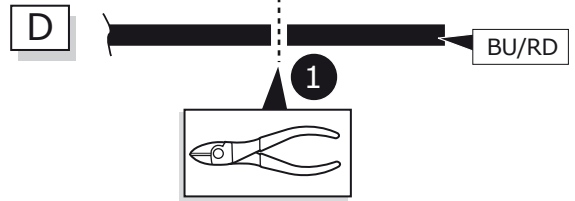

- (DE) Klebeband entfernen
- (FR) Enlevez Ruban adhésif
- (NL) Tape verwijderen
- (GB) Remove tape
- (ES) Retirar la cinta adhesiva
- (IT) Rimuovere il nastro adesivo

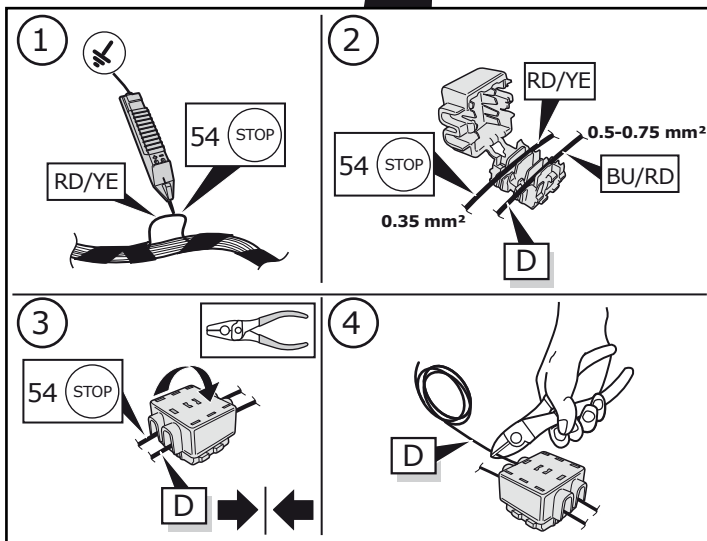
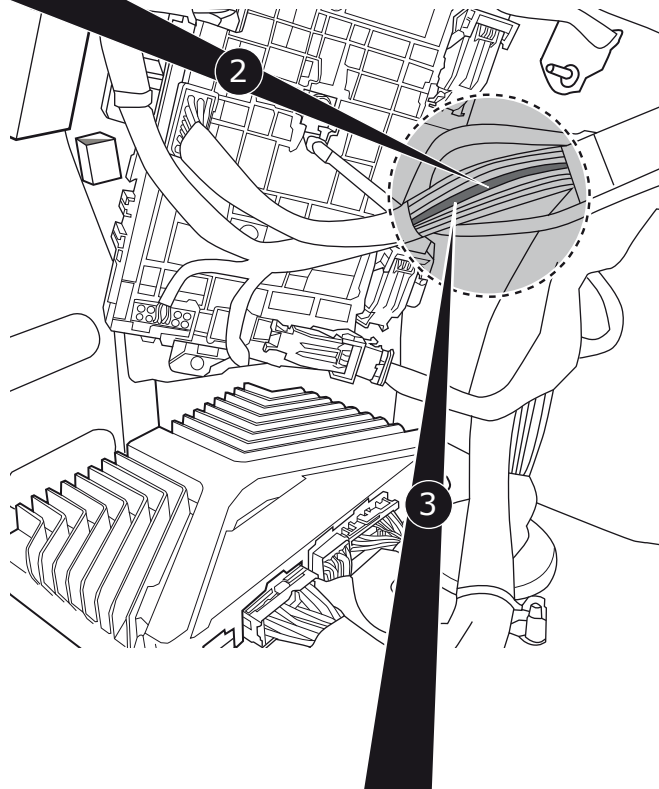

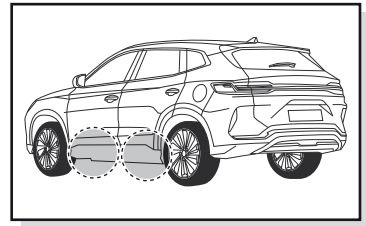
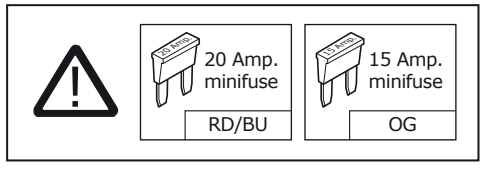
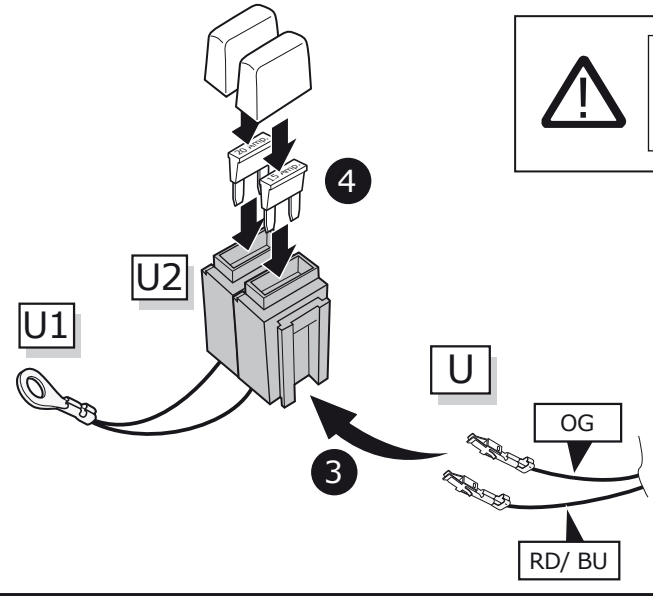
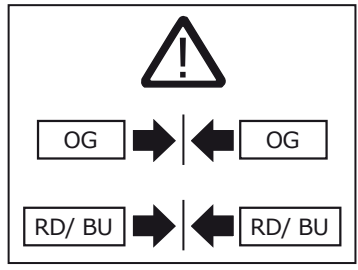
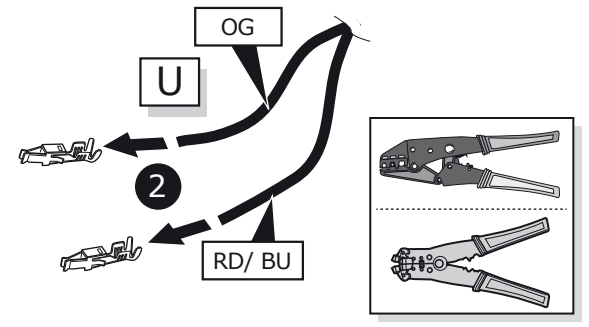
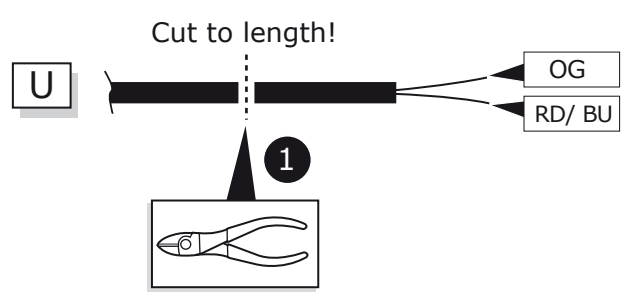

**BYD Seal U**

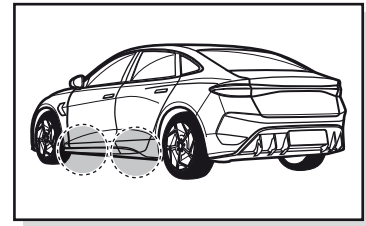

**BYD Seal**

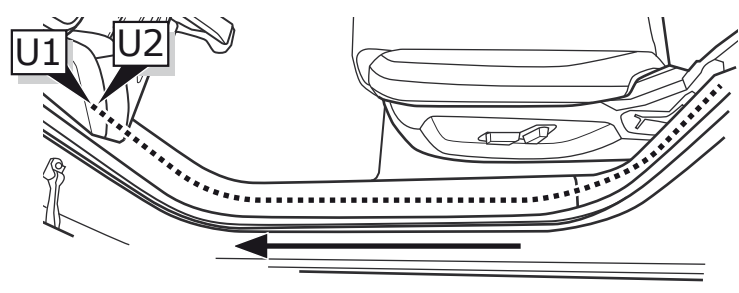
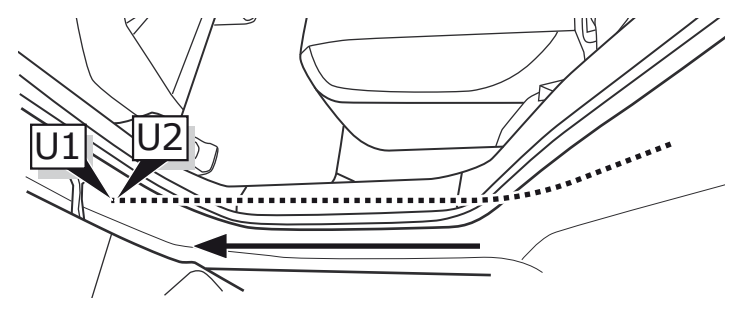

30

**BYD Seal**

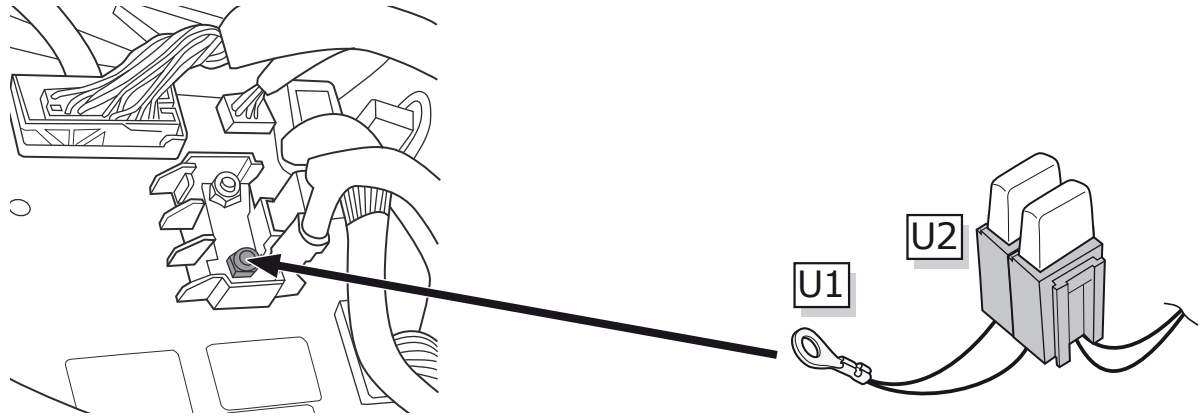
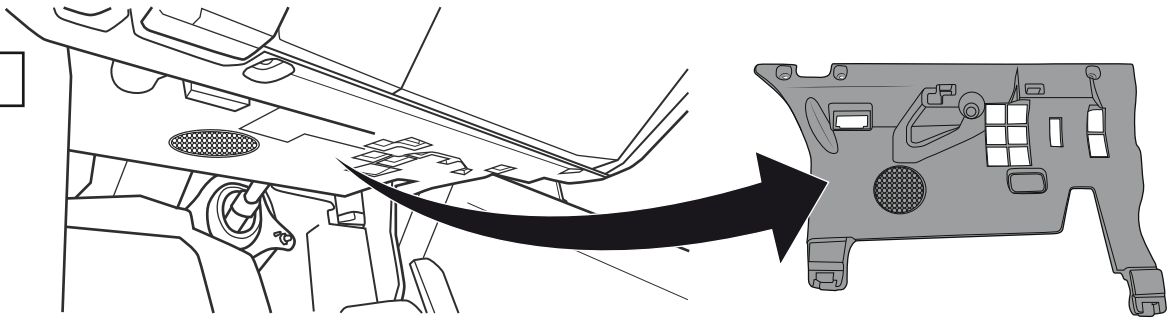

31

**BYD Seal U**

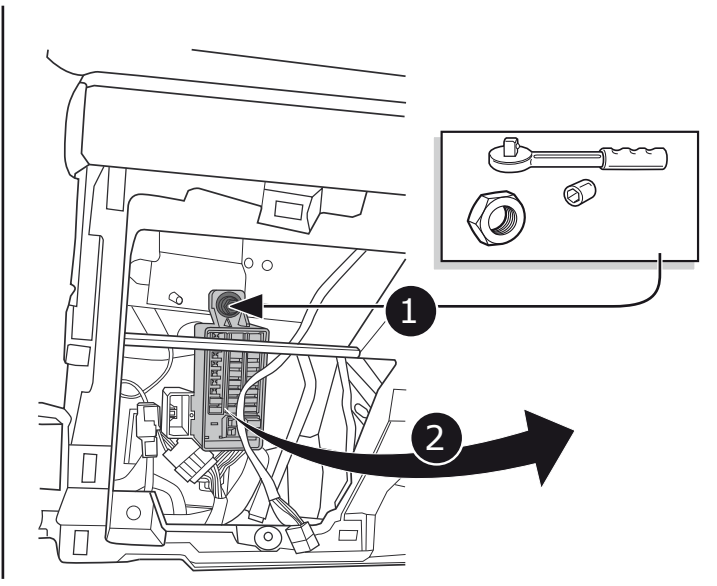
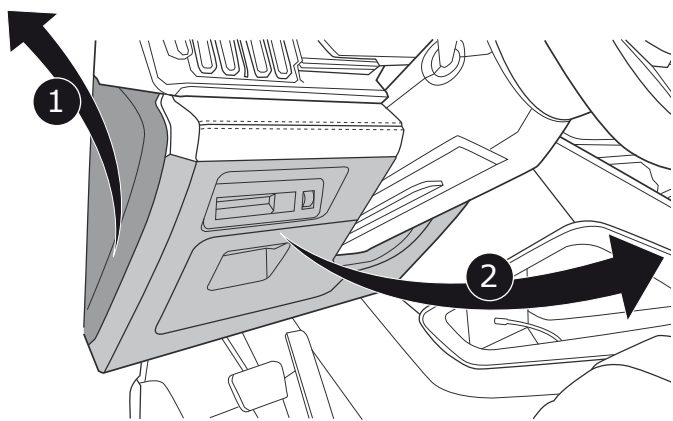

32

**BYD Seal U**

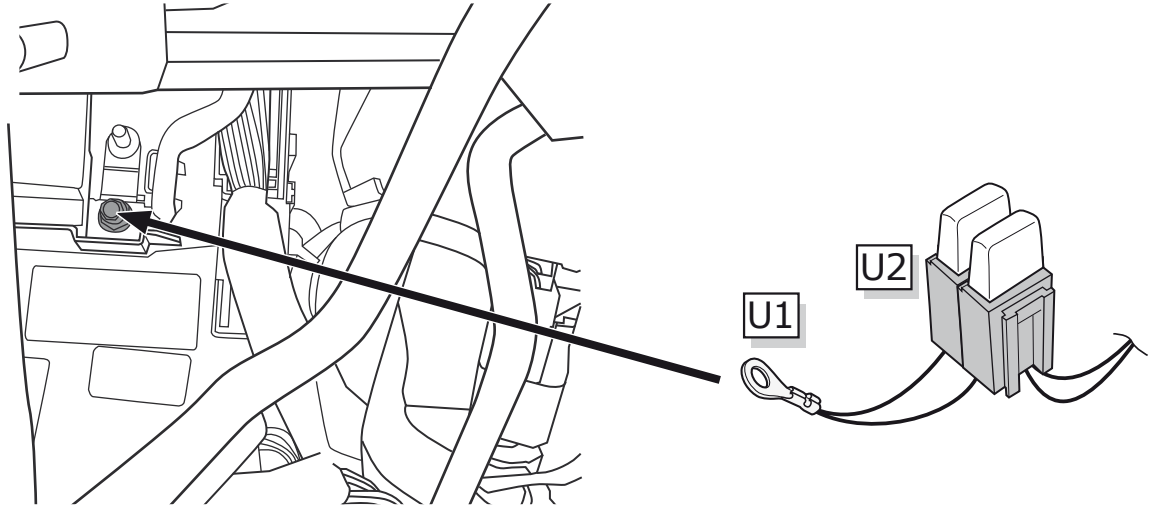

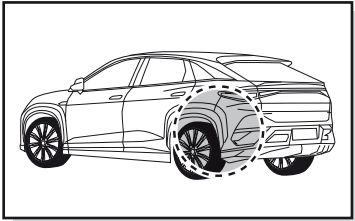

**BYD SeaLion 7**

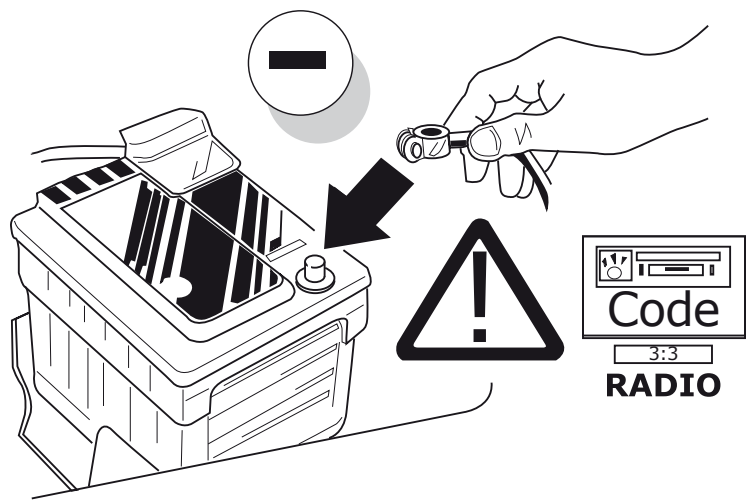
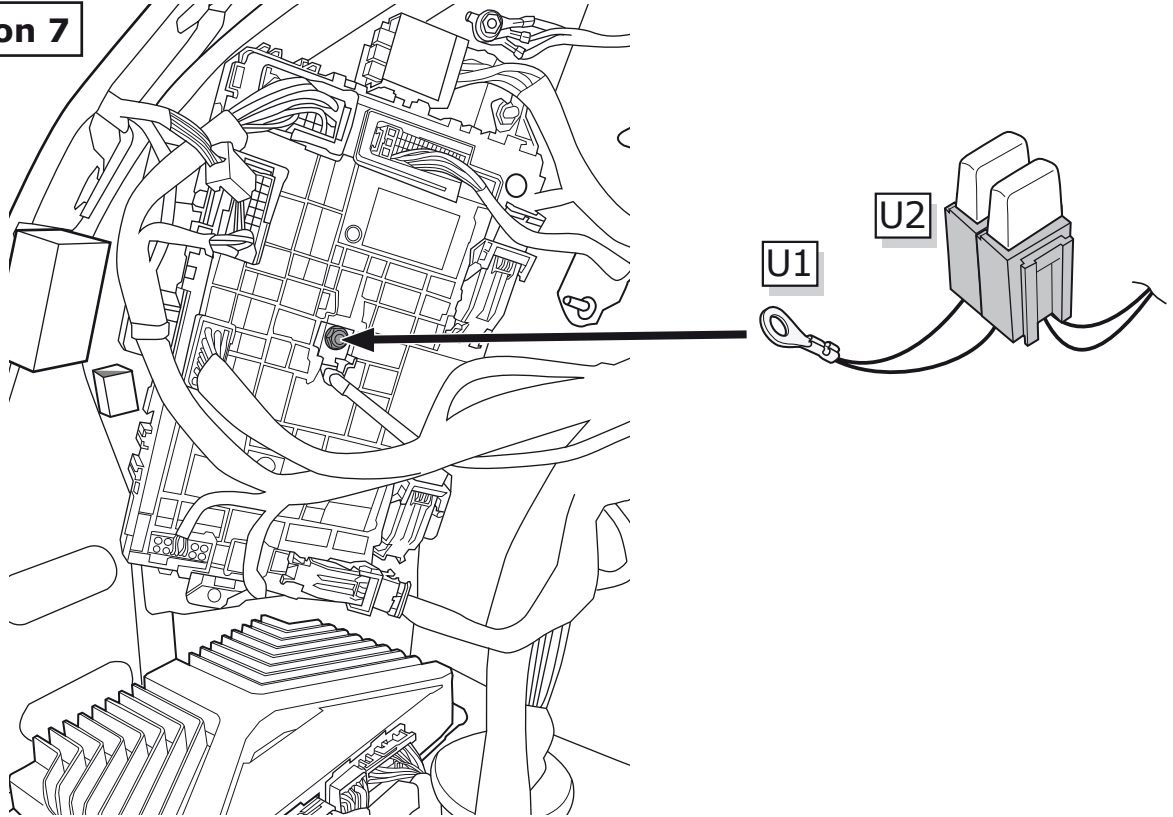

**Functional test**

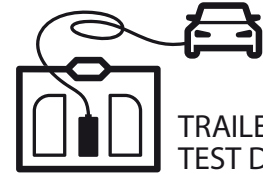
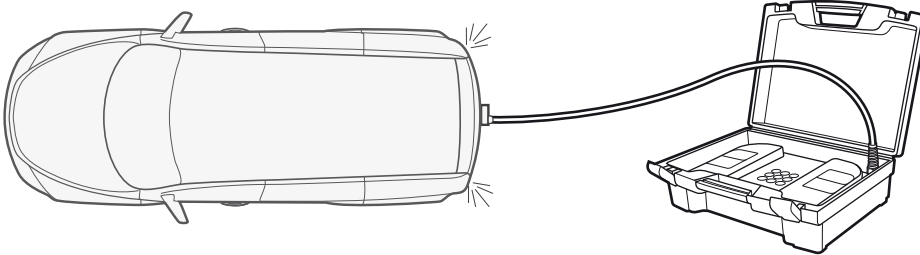
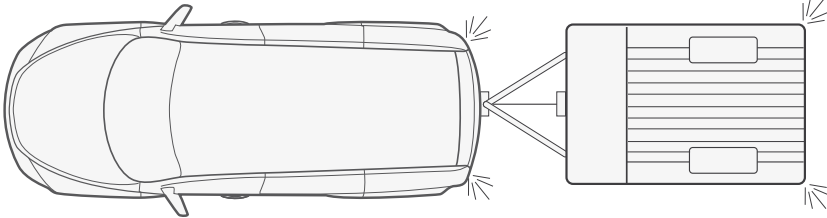
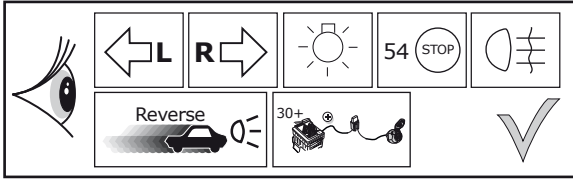

TRAILER  
TEST DEVICE  
**ECS** part no.  
**TD001ZZ**

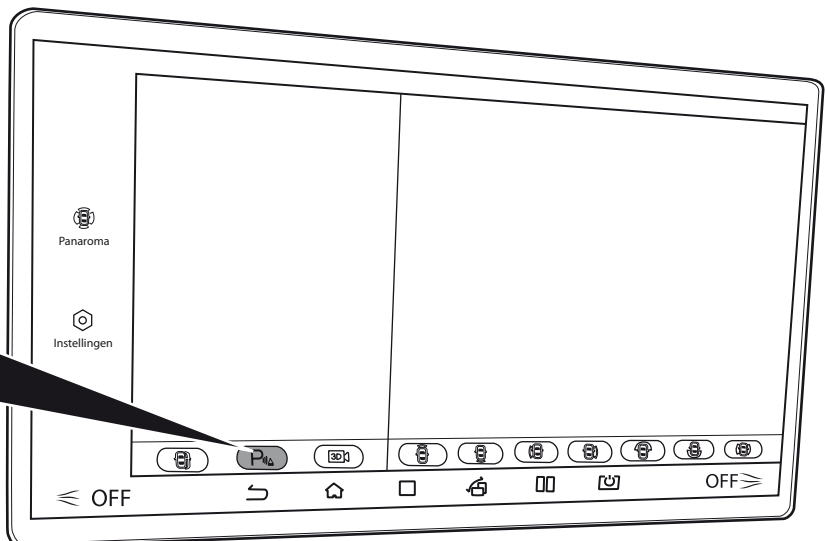
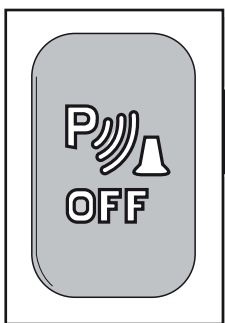
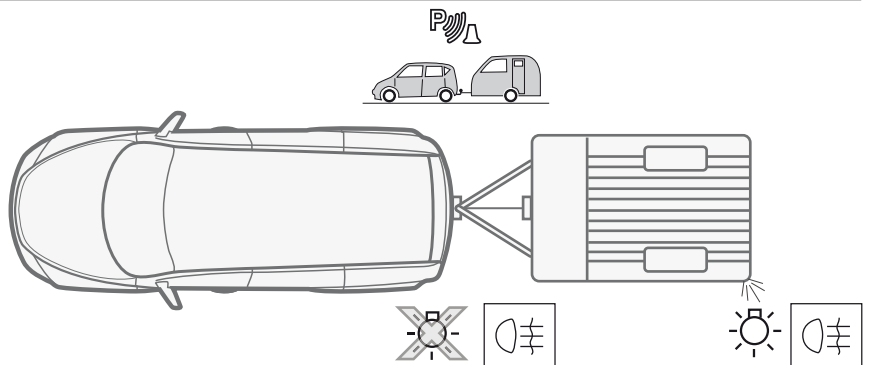
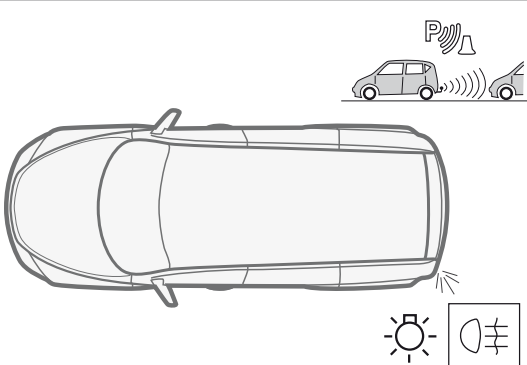
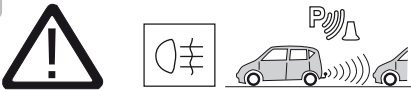

# ADAS OFF via Display

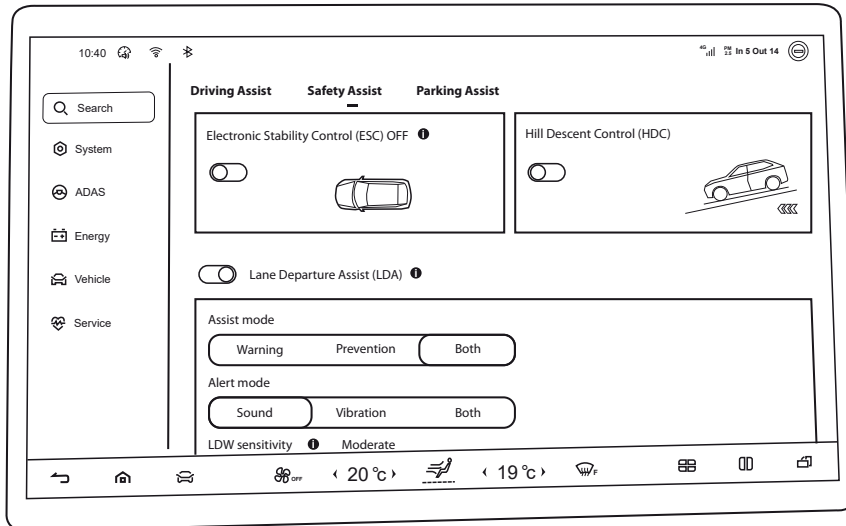
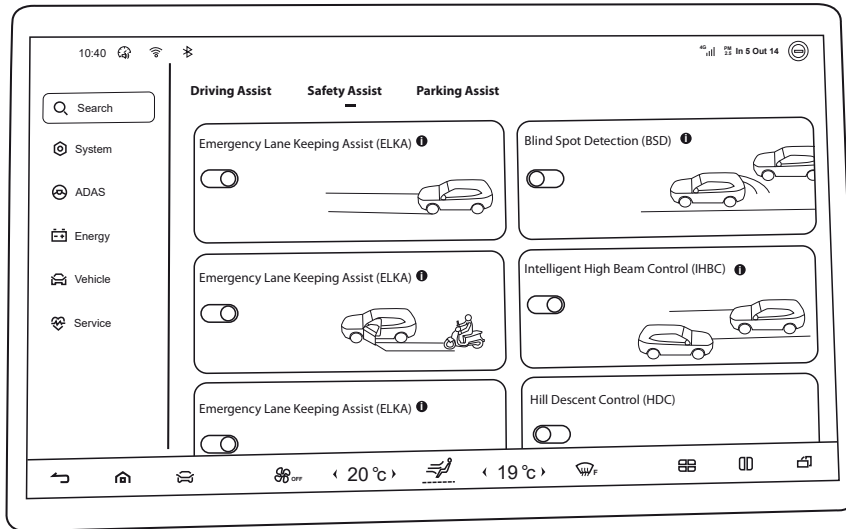
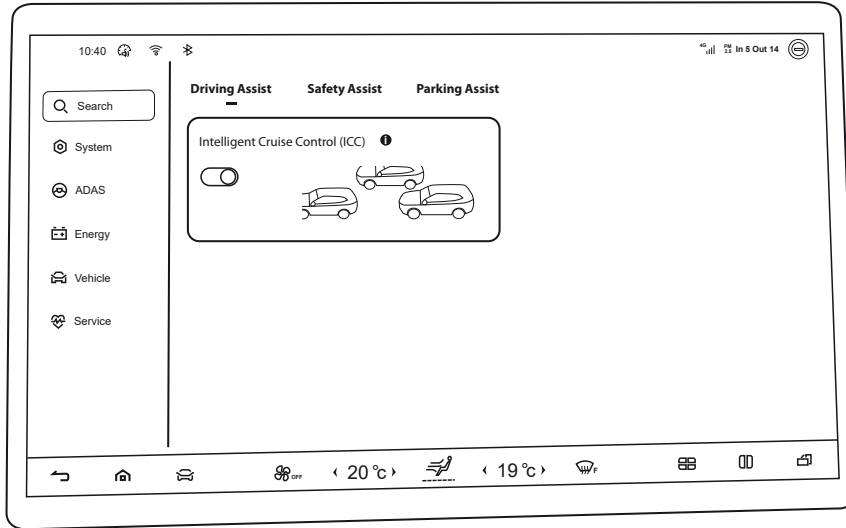

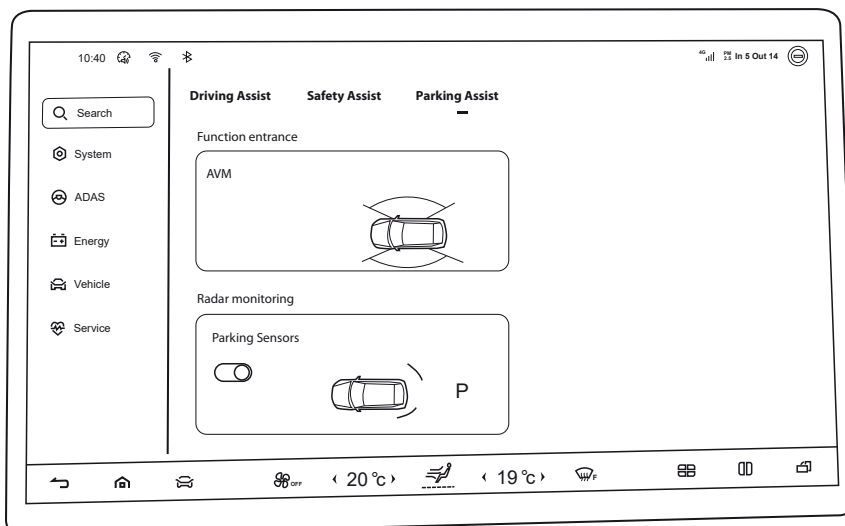
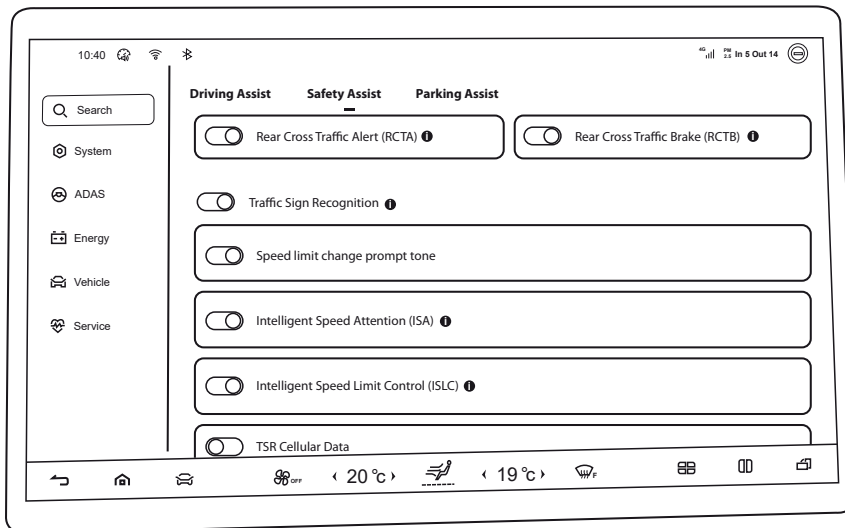
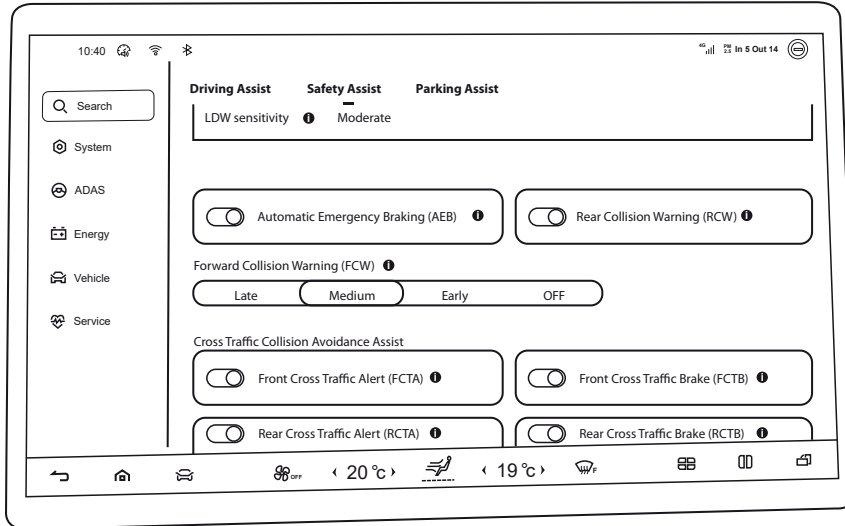

40

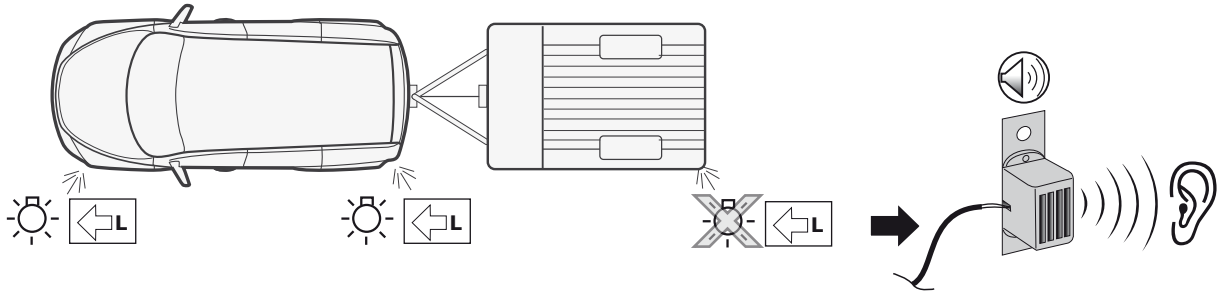

41

**Optional**  
**Adapter socket**

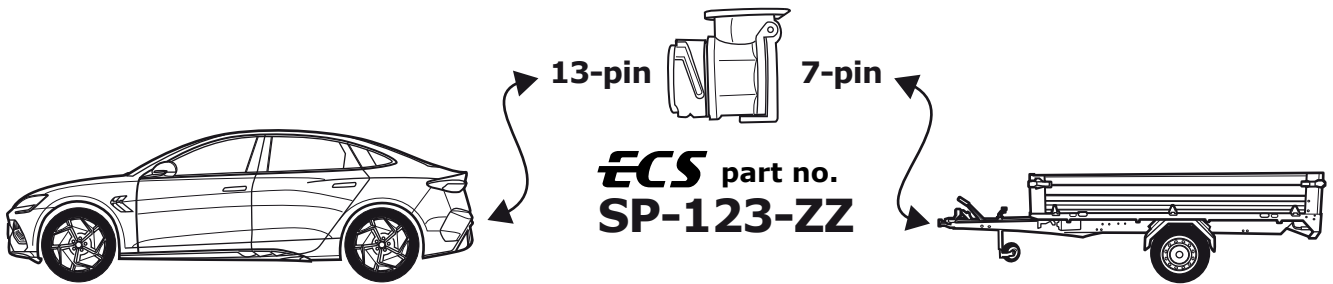

42

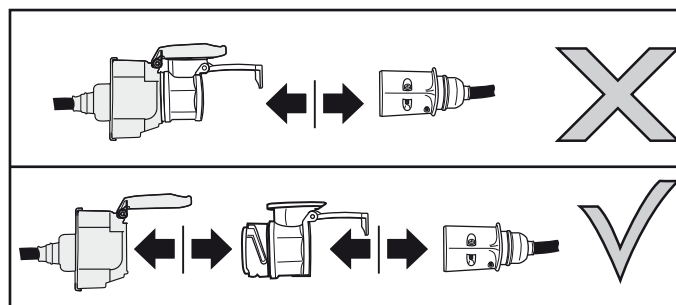
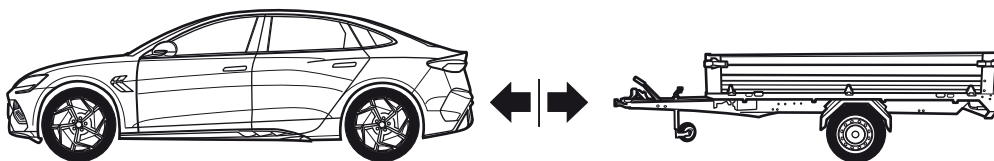

**Products & Service:** <https://www.ecs-electronics.nl/test-equipment>

**CANfinder®**

**ECS** part no.  
**CF001ZZ**

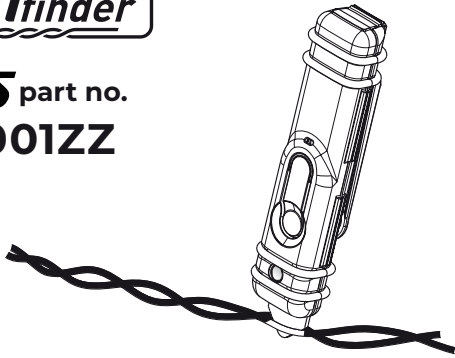

TRAILER  
TEST DEVICE

**ECS** part no.  
**TD001ZZ**

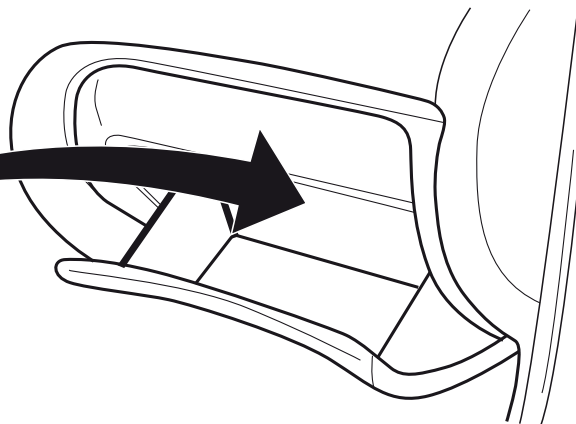
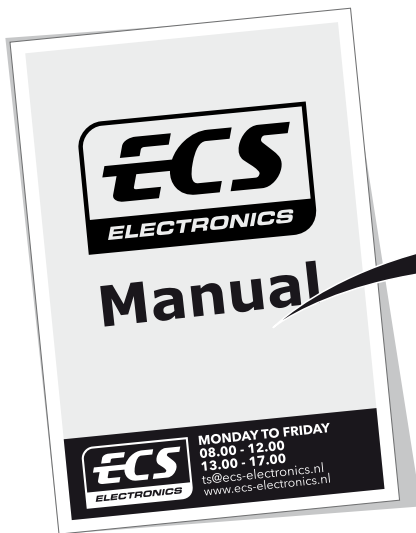
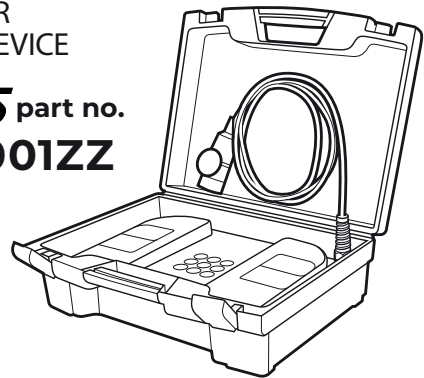

**FITTERS  
TECHNICAL  
SUPPORT**



**MONDAY TO FRIDAY**  
**08.00 - 12.00**  
**13.00 - 17.00**

[ts@ecs-electronics.nl](mailto:ts@ecs-electronics.nl)  
[www.ecs-electronics.nl](http://www.ecs-electronics.nl)  
tel: +31 (0)76 573 0020

**INFO**

- (DE) Anschluss Steckdose      (ES) Conexión de la caja de enchufe      (CZ) Objímkový konektor      (GR) Υποδοχή σύνδεσης
- (FR) Connection de la prise      (IT) Allaccio zoccolo      (DK) Stikdåse forbindelse      (NO) Tilkobling koblingsboks
- (NL) Contactdoos aansluiting      (SE) Anslutning kontaktdosa      (FI) Pistorasia liitäntä      (PL) Połączenie przez gniazdo
- (GB) Socket connection

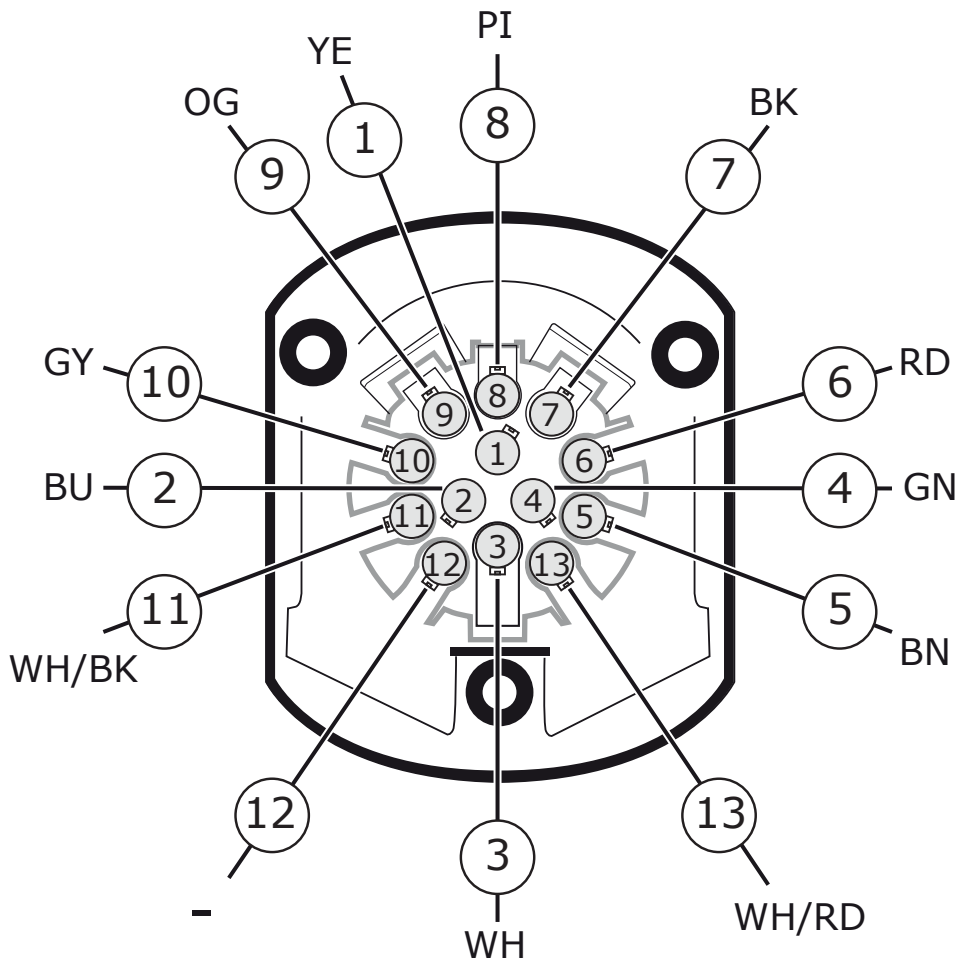
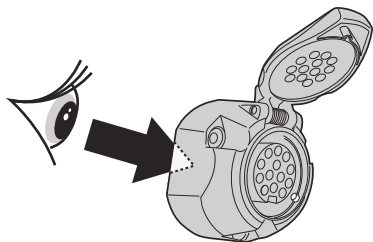

- (DE) Anschluss Steckdose      (ES) Conexión de la caja de enchufe      (CZ) Objímkový konektor      (GR) Υποδοχή σύνδεσης
- (FR) Connection de la prise      (IT) Allaccio zoccolo      (DK) Stikdåse forbindelse      (NO) Tilkobling koblingsboks
- (NL) Contactdoos aansluiting      (SE) Anslutning kontaktdosa      (FI) Pistorasia liitäntä      (PL) Połączenie przez gniazdo
- (GB) Socket connection

DIN/ISO 11446													
Pmax	21W	21W		21W	52W	3x21W	52W	21W	180W/15Amp	OPTION			
	YE	BU	WH	GN	BN	RD	BK	PI	OG	GY	WH/BK	-	WH/RD

**COLORTABLE**

	BK	BN	BU	GY	GN	WH	YE	OG	PE	PI	RD
(DE)	Schwarz	Braun	Blau	Grau	Grün	Weiß	Gelb	Orange	Violett	Rosa	Rot
(FR)	Noir	Marron	Blue	Gris	Vert	Blanc	Jaune	Orange	Violet	Rose	Rouge
(NL)	Zwart	Bruin	Blauw	Grijs	Groen	Wit	Geel	Oranje	Paars	Roze	Rood
(GB)	Black	Brown	Blue	Grey	Green	White	Yellow	Orange	Purple	Pink	Red
(ES)	Negro	Marrón	Azul	Gris	Verde	Blanco	Amarillo	Naranja	Morado	Rosa	Rojo
(IT)	Nero	Marrone	Blu	Grigio	Verde	Bianco	Giallo	Arancione	Viola	Rosa	Rosso
(SE)	Svart	Brun	Blå	Grå	Grön	Vit	Gul	Orange	Lila	Rosa	Röd
(CZ)	Černá	Hnědá	Modrá	Šedá	Zelená	Bílá	Žlutá	Oranžová	Fialová	Růžová	Červená
(DK)	Sort	Brun	Blå	Grå	Grøn	Hvid	Gul	Orange	Lilla	Pink	Rød
(FI)	Musta	Ruskea	Sininen	Harmaa	Vihreä	Valkoinen	Keltainen	Oranssi	Purppura	Vaaleanpunainen	Punainen
(GR)	Μαύρο	Καφέ	Μπλε	Γκρι	Πράσινο	Λευκό	Κίτρινο	Πορτοκαλί	Μοβ	Ροζ	Κόκκινο
(NO)	Svart	Brun	Blå	Grå	Grønn	Hvit	Gul	Oransje	Lilla	Rosa	Rød
(PL)	Czarny	Brazowy	Niebieski	Szary	Zielony	Biały	Żółty	Pomarańczowy	Purpurowy	Różowy	Czerwony